

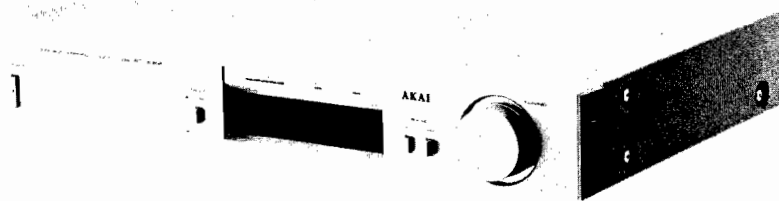

AT-K11/L

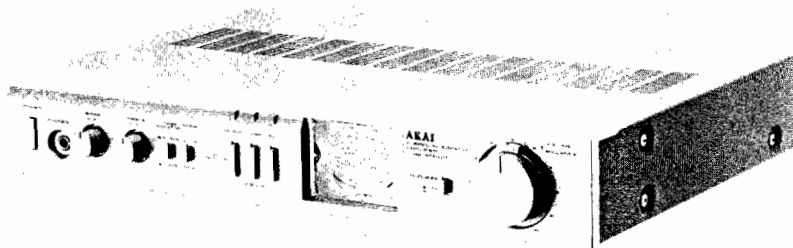

AT-K22/L



AM-U11

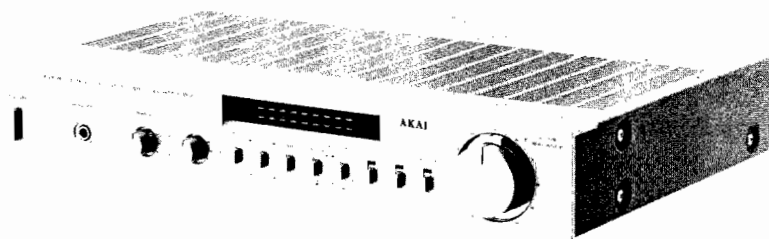

AM-U22

**FM AM STEREO TUNER**  
**AT-K11/L**  
**MODEL AT-K22/L**  
**STEREO INTEGRATED AMPLIFIER**  
**AM-U11**  
**MODEL AM-U22**

THIS MANUAL IS APPLICABLE TO BOTH SILVER AND BLACK PANEL MODELS

SECTION 1	MODEL AT-K11/L and AT-K22/L SERVICE MANUAL	3
SECTION 2	MODEL AM-U11 and AM-U22 SERVICE MANUAL	27
SECTION 3	PARTS LIST	47
SECTION 4	SCHEMATIC DIAGRAM	73

---

SECTION 1

**SERVICE MANUAL**  
**MODEL AT-K11/L, AT-K22/L**

TABLE OF CONTENTS

I.	TECHNICAL DATA .....	4
	1. MODEL AT-K11/L .....	4
	2. MODEL AT-K22/L .....	5
II.	DISMANTLING OF UNIT .....	6
	1. MODEL AT-K11/L .....	6
	2. MODEL AT-K22/L .....	7
III.	CONTROLS .....	8
	1. MODEL AT-K11/L .....	8
	2. MODEL AT-K22/L .....	9
IV.	PRINCIPAL PARTS LOCATION .....	10
	1. MODEL AT-K11/L .....	10
	2. MODEL AT-K22/L .....	11
V.	VOLTAGE CONVERSION .....	12
VI.	TUNER ADJUSTMENTS .....	13
	1. FM SECTION ADJUSTMENTS .....	16
	2. AM(AT-K11 L and AT-K22 L:MW) SECTION ADJUSTMENTS .....	18
	3. LW SECTION ADJUSTMENTS .....	19
VII.	TUNING CORD THREADING .....	20
	1. MODEL AT-K11/L .....	20
	2. MODEL AT-K22/L .....	20
VIII.	CLASSIFICATION OF VARIOUS P.C BOARDS .....	21
	1. P.C. BOARD TITLES AND IDENTIFICATION NUMBERS .....	21
	2. COMPOSITION OF VARIOUS P.C BOARDS .....	22

For basic adjustments, measuring methods, and operating principles, refer to GENERAL TECHNICAL MANUAL.

# I . TECHNICAL DATA

## 1. MODEL AT-K11/L

### FM TUNER SECTION

TUNING FREQUENCY RANGE	87.5 MHz to 108.0 MHz
USABLE SENSITIVITY (IHF) (300 ohms)	1.9 $\mu$ V
CAPTURE RATIO	1.3 dB
SELECTIVITY (IHF) (400 kHz)	60 dB
IMAGE REJECTION	55 dB
IF REJECTION	85 dB
SPURIOUS REJECTION	85 dB
AM SUPPRESSION	60 dB
SUB CARRIER SUPPRESSION	60 dB
S/N (MONO/STEREO)	70 dB/65 dB
T.H.D. (MONO/STEREO)	0.1%/0.15%
STEREO SEPARATION (1 kHz)	45 dB
MUTING LEVEL (INPUT LEVEL)	22 dB

### AM TUNER SECTION (MW FOR AT-K11L)

TUNING FREQUENCY RANGE	525 kHz to 1,605 kHz
USABLE SENSITIVITY (IHF) BAR ANTENNA	100 $\mu$ V/m
EXTERNAL ANTENNA	10 $\mu$ V
SELECTIVITY (IHF)	30 dB
IMAGE REJECTION	48 dB
IF REJECTION	33 dB
S/N	50 dB
T.H.D.	0.3%

### LW TUNER SECTION (AT-K11L ONLY)

TUNING FREQUENCY RANGE	135 kHz to 350 kHz
USABLE SENSITIVITY (IHF) BAR ANTENNA	200 $\mu$ V/m
EXTERNAL ANTENNA	17 $\mu$ V
SELECTIVITY (IHF)	30 dB
IMAGE REJECTION	45 dB
IF REJECTION	33 dB
S/N	50 dB
T.H.D.	0.3%

### OUTPUT SECTION

OUTPUT LEVEL FM(100% MOD.)	775 mV
AM(30% MOD.)	250 mV
OUTPUT IMPEDANCE	3.3 kohms
POWER REQUIREMENTS	120 V, 60 Hz for U.S.A. and Canada 220 V, 50 Hz for Europe except UK 240 V, 50 Hz for UK and Australia 110 V/220 V/240 V, 50/60 Hz internally switchable for other countries.
DIMENSIONS	440(W) x 78(H) x 333(D) mm (17.3 x 3.1 x 13.1 inches)
WEIGHT	4.6 kg (10.1 lbs)

\* For improvement purposes, specifications and design are subject to change without notice.

## 2. MODEL AT-K22/L

### FM TUNER SECTION

TUNING FREQUENCY RANGE	87.5 MHz to 108.0 MHz
USABLE SENSITIVITY (IHF) (300 ohms)	1.9 $\mu$ V
CAPTURE RATIO	1.3 dB
SELECTIVITY (IHF) (400 kHz)	65 dB
IMAGE REJECTION	56 dB
IF REJECTION	90 dB
SPURIOUS REJECTION	85 dB
AM SUPPRESSION	60 dB
SUB CARRIER SUPPRESSION	60 dB
S/N (MONO/STEREO)	73 dB/65 dB
T.H.D. (MONO/STEREO)	0.1%/0.15%
STEREO SEPARATION (1 kHz)	45 dB
MUTING LEVEL (INPUT LEVEL)	22 dB

### AM TUNER SECTION (MW FOR AT-K22L)

TUNING FREQUENCY RANGE	525 kHz to 1,605 kHz
USABLE SENSITIVITY (IHF) (BAR)	100 $\mu$ V/m
SELECTIVITY (IHF)	30 dB
IMAGE REJECTION	48 dB
IF REJECTION	33 dB
S/N	50 dB
T.H.D.	0.3%

### LW TUNER SECTION (AT-K22L ONLY)

TUNING FREQUENCY RANGE	135 kHz to 350 kHz
USABLE SENSITIVITY (IHF)	
BAR ANTENNA	200 $\mu$ V/m
EXTERNAL ANTENNA	17 $\mu$ V
SELECTIVITY (IHF)	30 dB
IMAGE REJECTION	45 dB
IF REJECTION	33 dB
S/N	50 dB
T.H.D.	0.3%

### OUTPUT SECTION

OUTPUT LEVEL	FM(100% MOD.) AM(30% MOD.)	775 mV 250 mV
OUTPUT IMPEDANCE		3.3 kohms
POWER REQUIREMENTS		120 V, 60 Hz for U.S.A. and Canada 220 V, 50 Hz for Europe except UK 240 V, 50 Hz for UK and Australia 110 V/220 V/240 V, 50/60 Hz internally switchable for other countries.
DIMENSIONS		440(W) x 78(H) x 290(D) mm (17.3 x 3.1 x 11.4 inches)
WEIGHT		4.5 kg (9.9 lbs)

\* For improvement purposes, specifications and design are subject to change without notice.

## II. DISMANTLING OF UNIT

### 1. MODEL AT-K11/L

In case of trouble, etc. necessitating dismantling, please dismantle in the order shown in the photographs. Reassemble in reverse order.

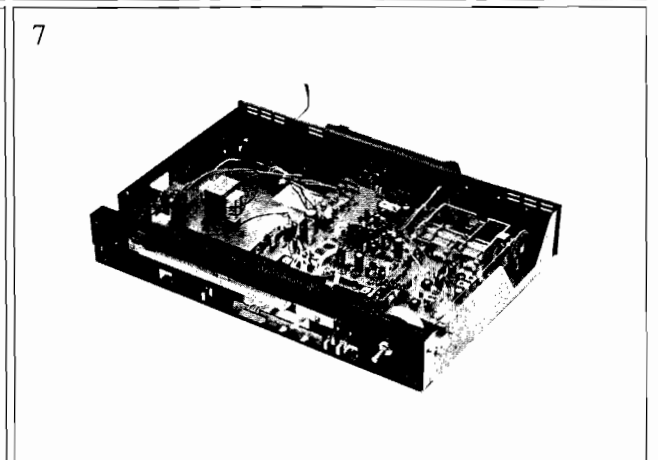
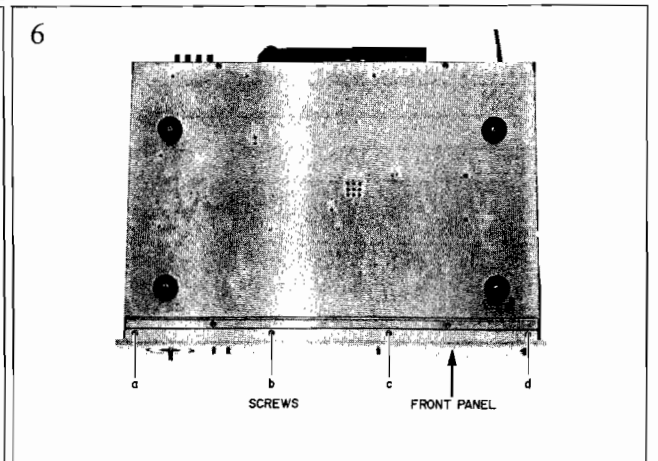
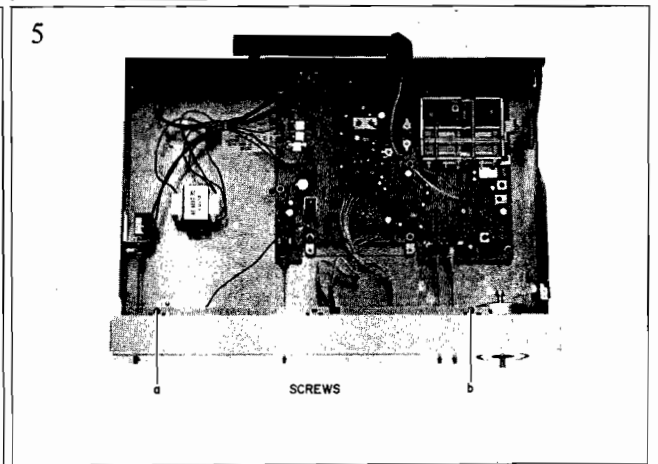
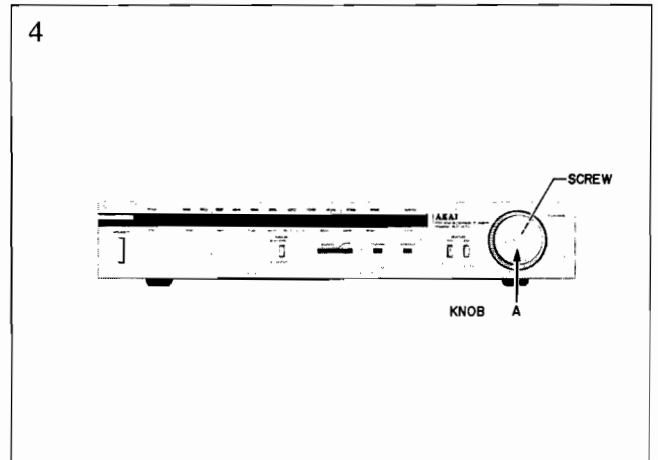
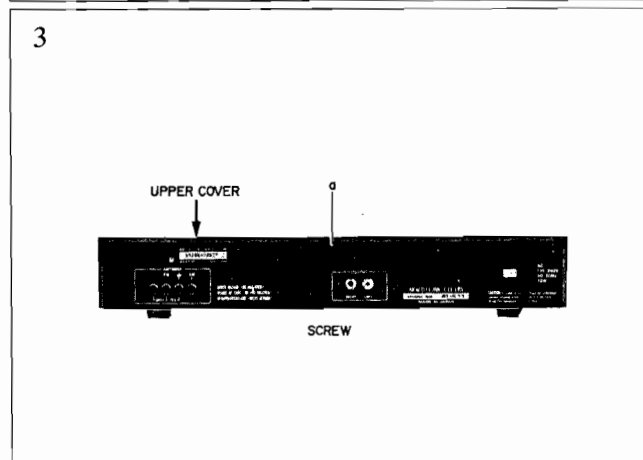
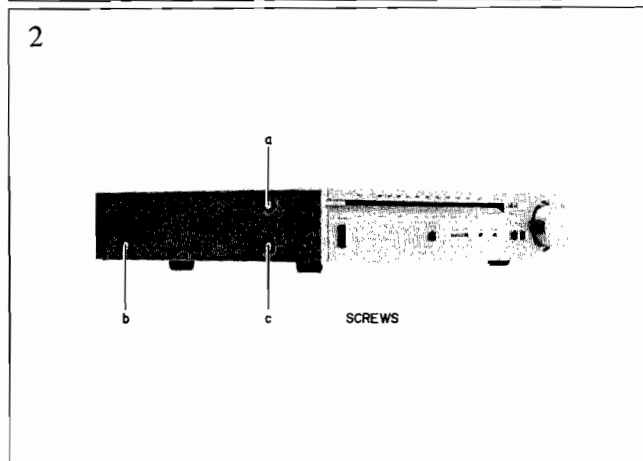
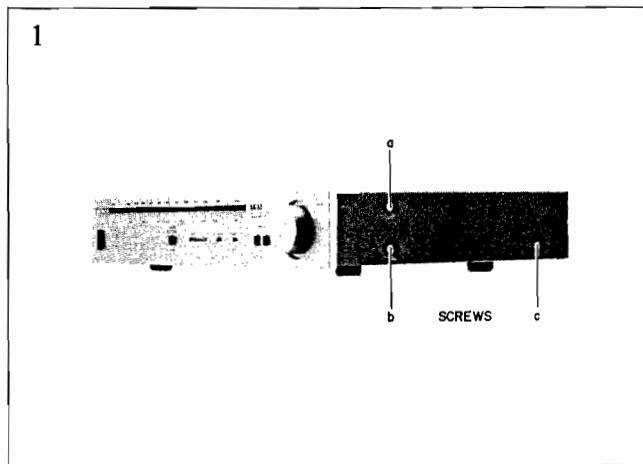

## 2. MODEL AT-K22/L

In case of trouble, etc. necessitating dismantling, please dismantle in the order shown in the photographs. Reassemble in reverse order.

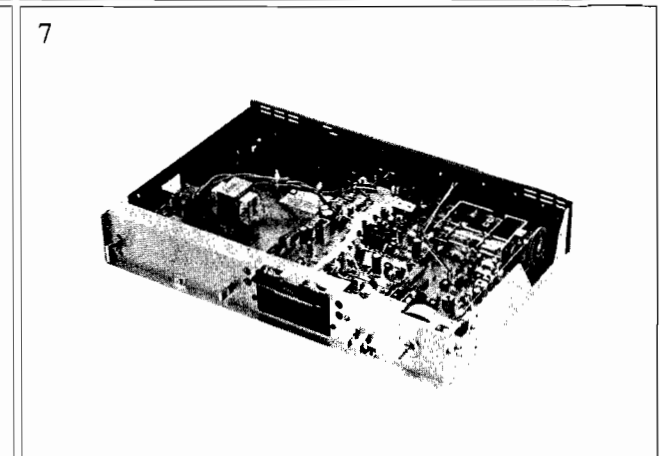
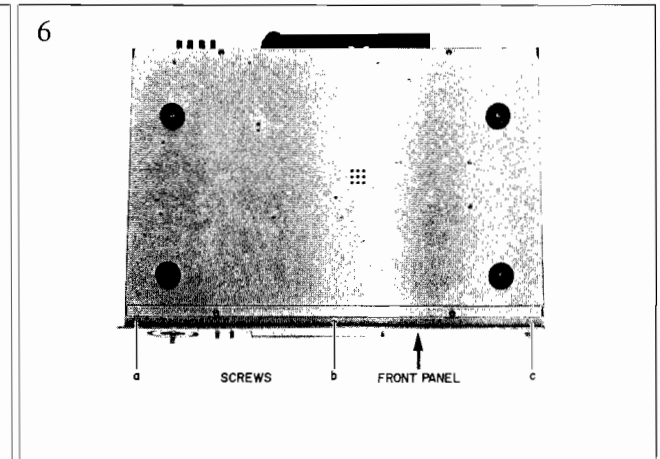
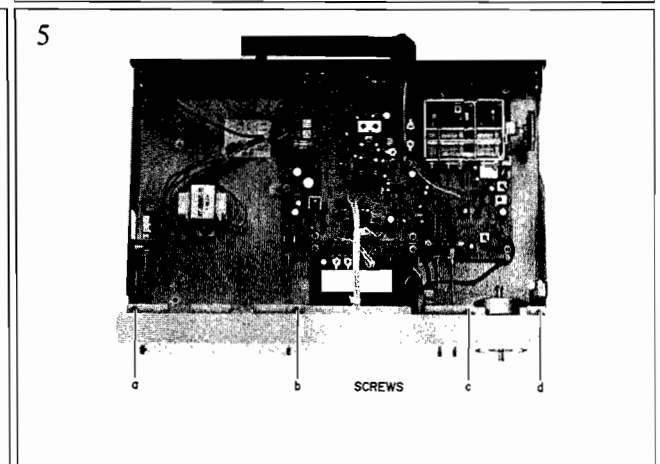
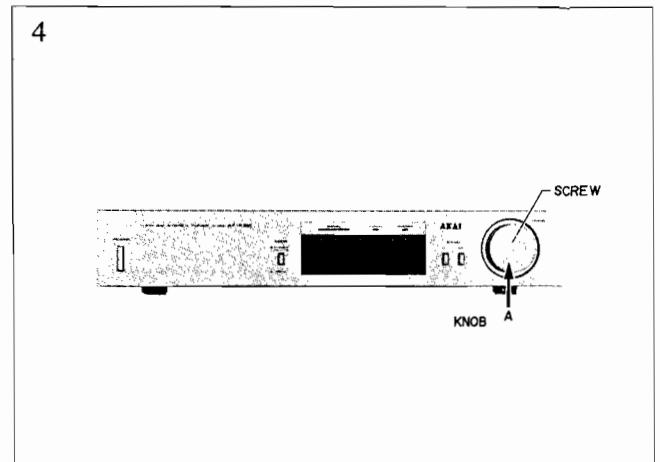
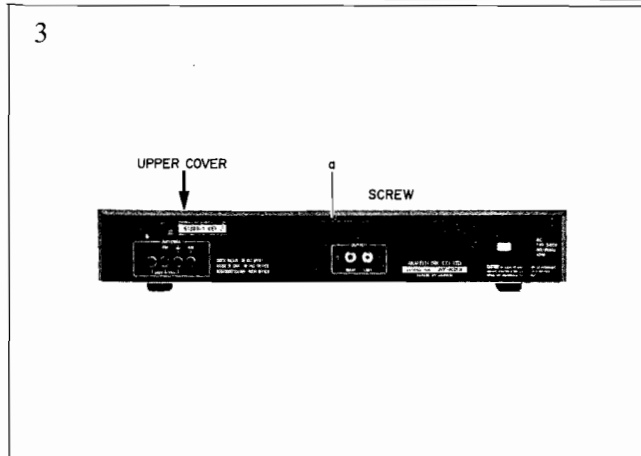
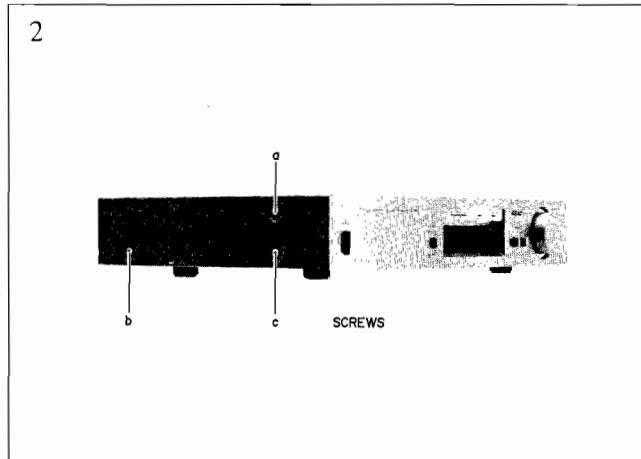
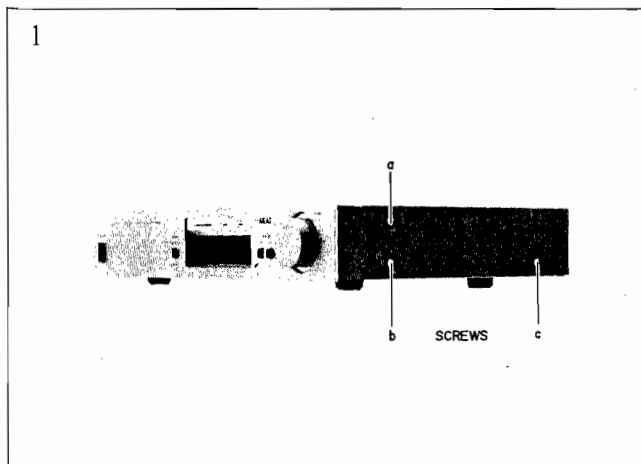

### III. CONTROLS

#### 1. MODEL AT-K11/L

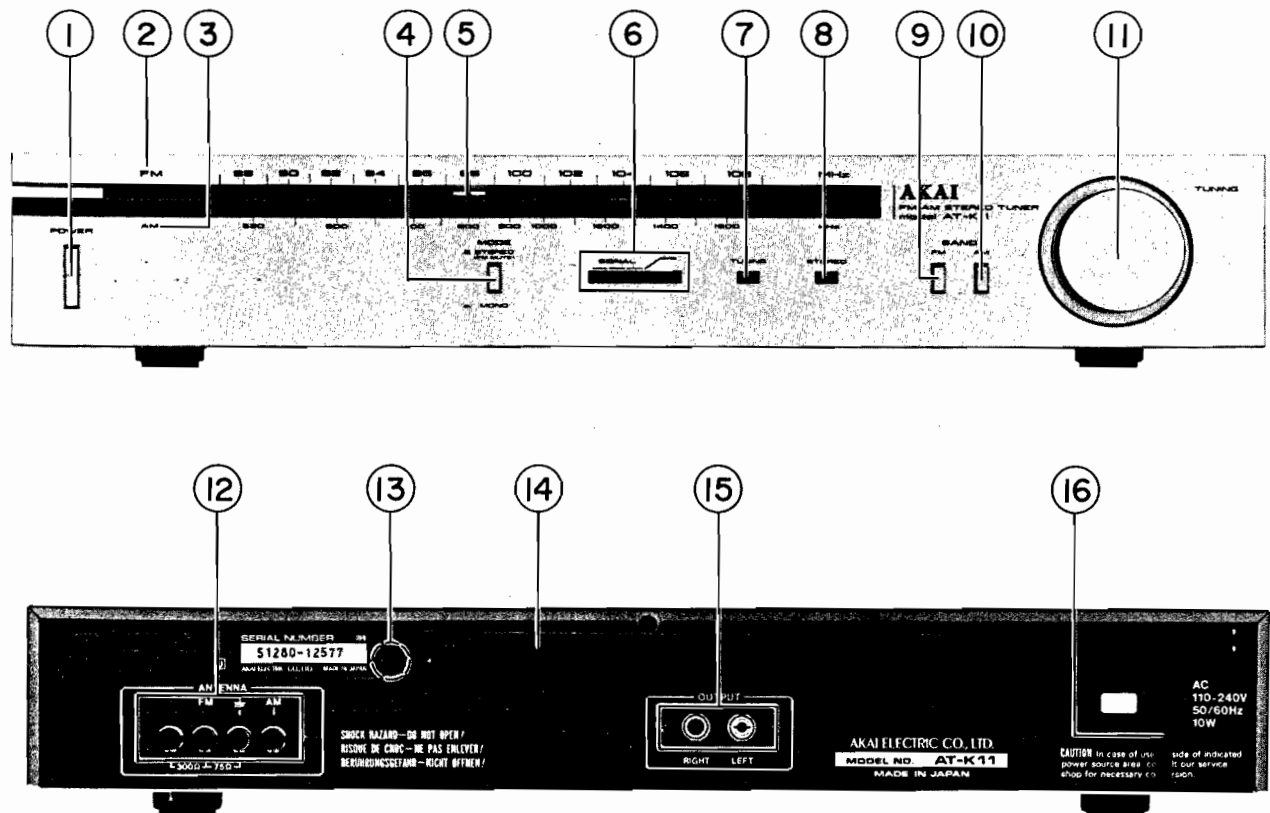

Fig. 1 Controls (AT-K11/L)

- |   |   |
|---|---|
| 1. POWER SWITCH   | 9. FM SWITCH (AT-K11)                                   |
| 2. FM DIAL SCALE (AT-K11)<br>LW AND MW DIAL SCALE (AT-K11L) | FM/AM BANK SELECTOR (AT-K11L)                           |
| 3. AM DIAL SCALE (AT-K11)<br>FM DIAL SCALE (AT-K11L)        | 10. AM SWITCH (AT-K11)<br>MW/LW BAND SELECTOR (AT-K11L) |
| 4. FM MODE SELECTOR   | 11. TUNING KNOB   |
| 5. FREQUENCY INDICATOR                                      | 12. FM AND AM ANTENNA TERMINALS                         |
| 6. SIGNAL STRENGTH INDICATOR                                | 13. AM ANTENNA (ANT) SELECTOR (AT-K11 L ONLY)           |
| 7. FM TUNING INDICATOR                                      | 14. AM FERRITE BAR ANTENNA                              |
| 8. FM STEREO INDICATOR                                      | 15. OUTPUT JACKS (RIGHT AND LEFT)                       |
|   | 16. AC CORD (CEE, SAA AND UK: AC INLET)                 |

## 2. MODEL AT-K22/L

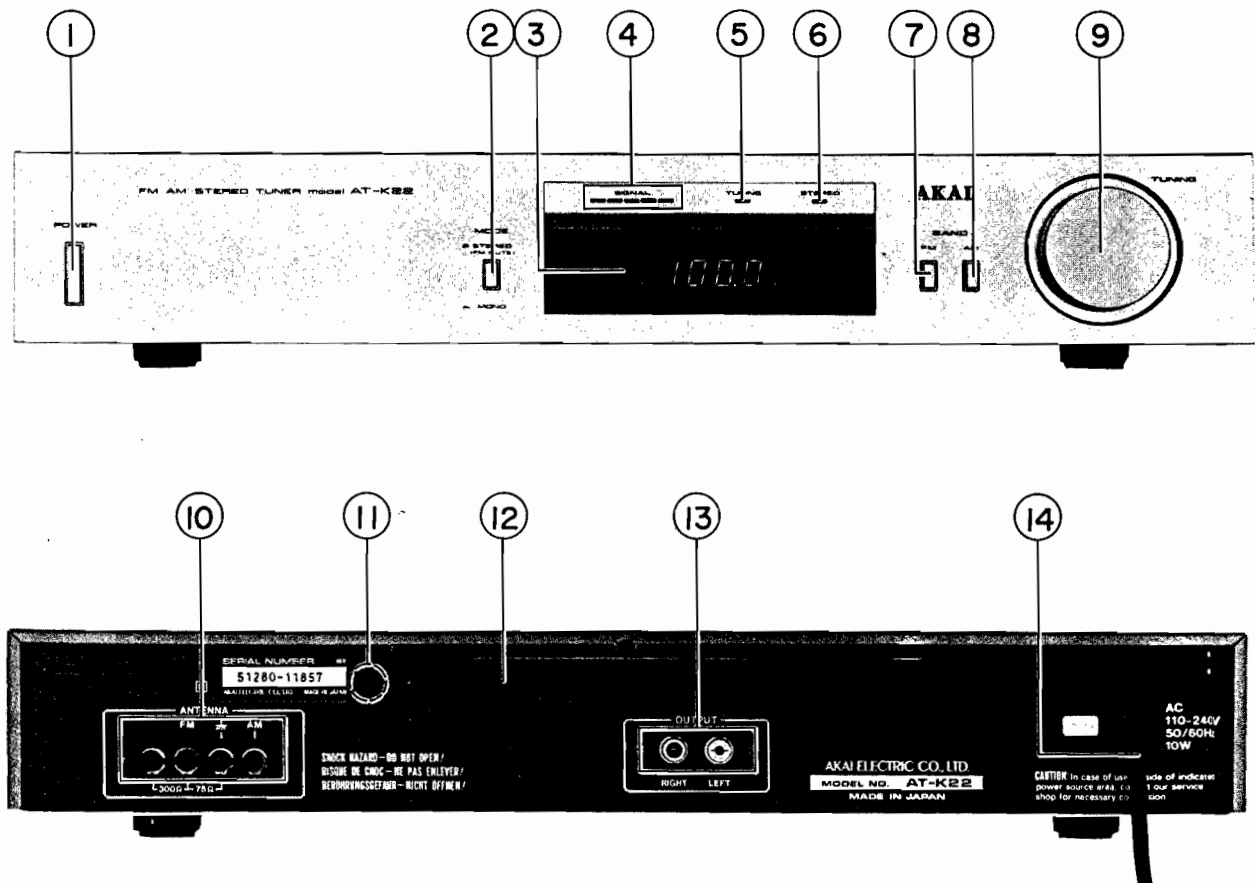

Fig. 2 Controls (AT-K22/L)

- |                               |  |
|-------------------------------|--|
| 1. POWER SWITCH               | 8. AM SWITCH (AT-K22)                        |
| 2. FM MODE SWITCH             | MW/LW BAND SELECTOR (AT-K22L)                |
| 3. DIGITAL LED DISPLAY        | 9. TUNING KNOB                               |
| 4. SIGNAL STRENGTH INDICATOR  | 10. FM AND AM ANTENNA TERMINALS              |
| 5. FM TUNING INDICATOR        | 11. AM ANTENNA (ANT) SELECTOR (AT-K22L ONLY) |
| 6. FM STEREO INDICATOR        | 12. AM FERRITE BAR ANTENNA                   |
| 7. FM SWITCH (AT-K22)         | 13. OUTPUT JACKS (RIGHT AND LEFT)            |
| AM/FM BAND SELECTOR (AT-K22L) | 14. AC CORD (CEE, SAA AND UK: AC INLET)      |



# IV. PRINCIPAL PARTS LOCATION

## 1. MODEL AT-K11/L

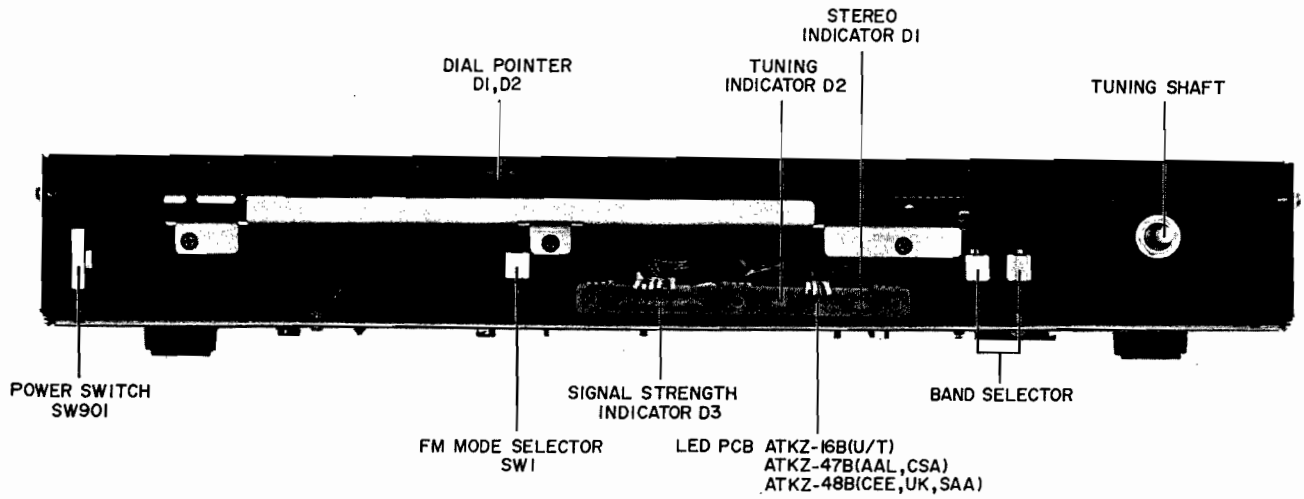

Fig. 3 Front View

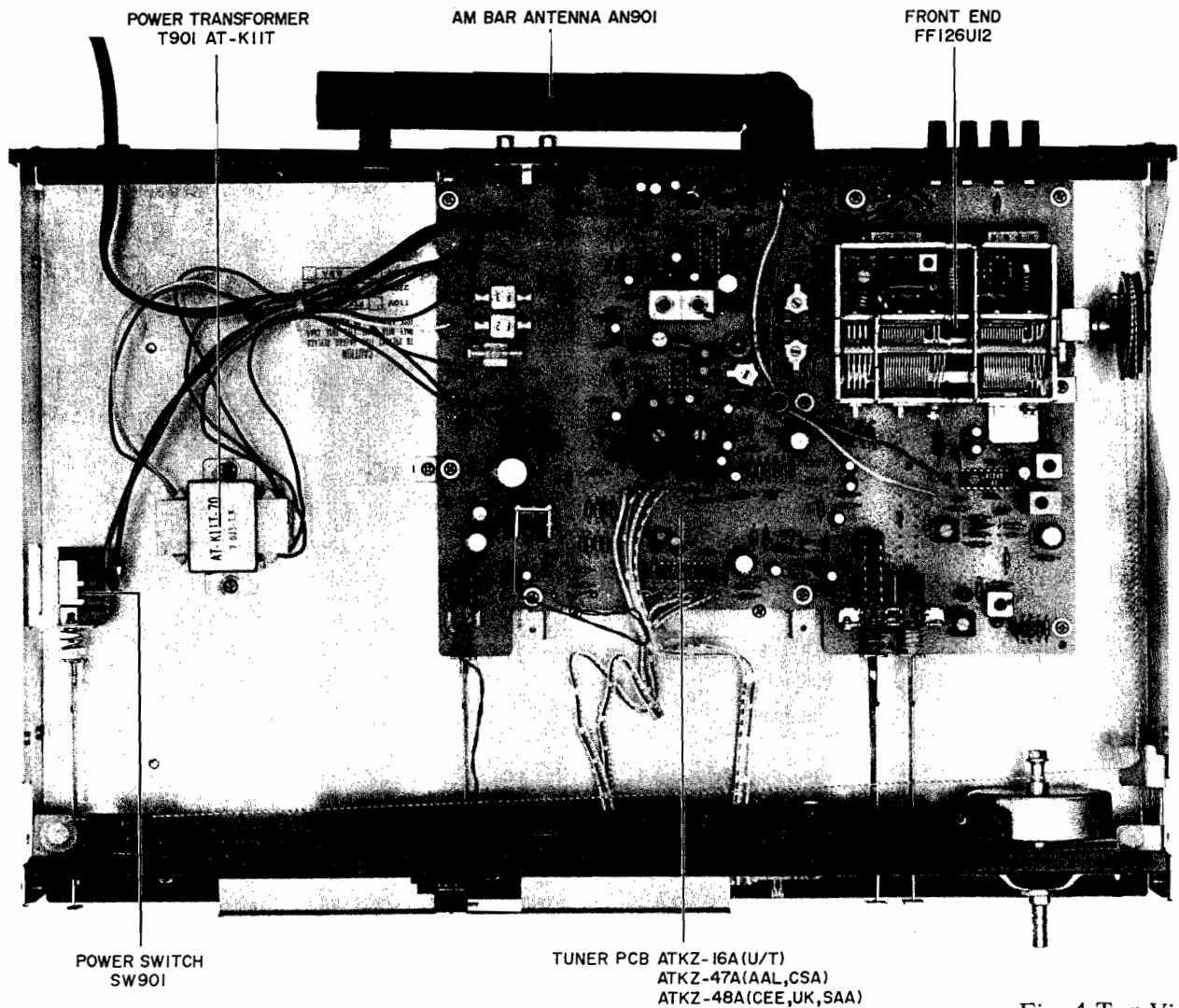

Fig. 4 Top View

2. MODEL AT-K22/L

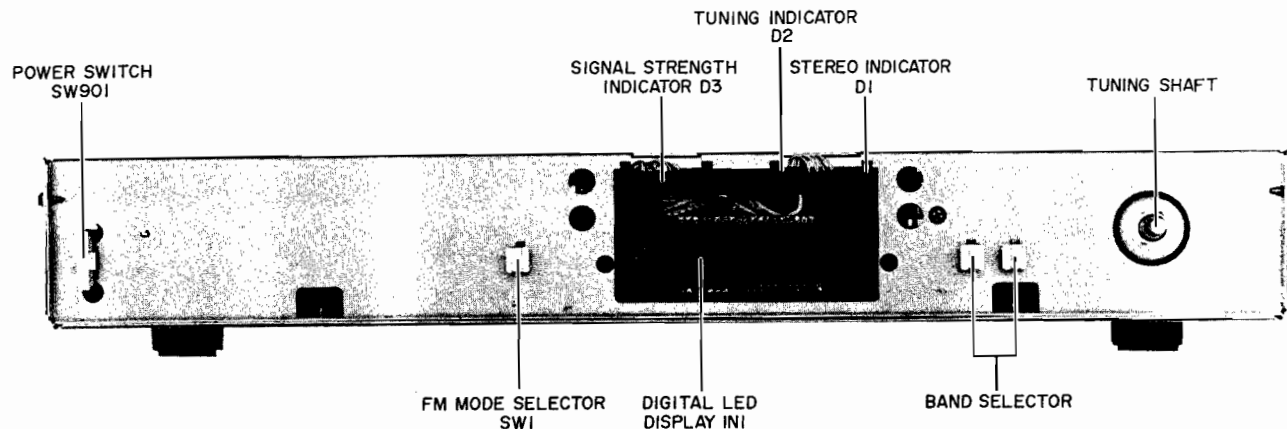

Fig. 5 Front View

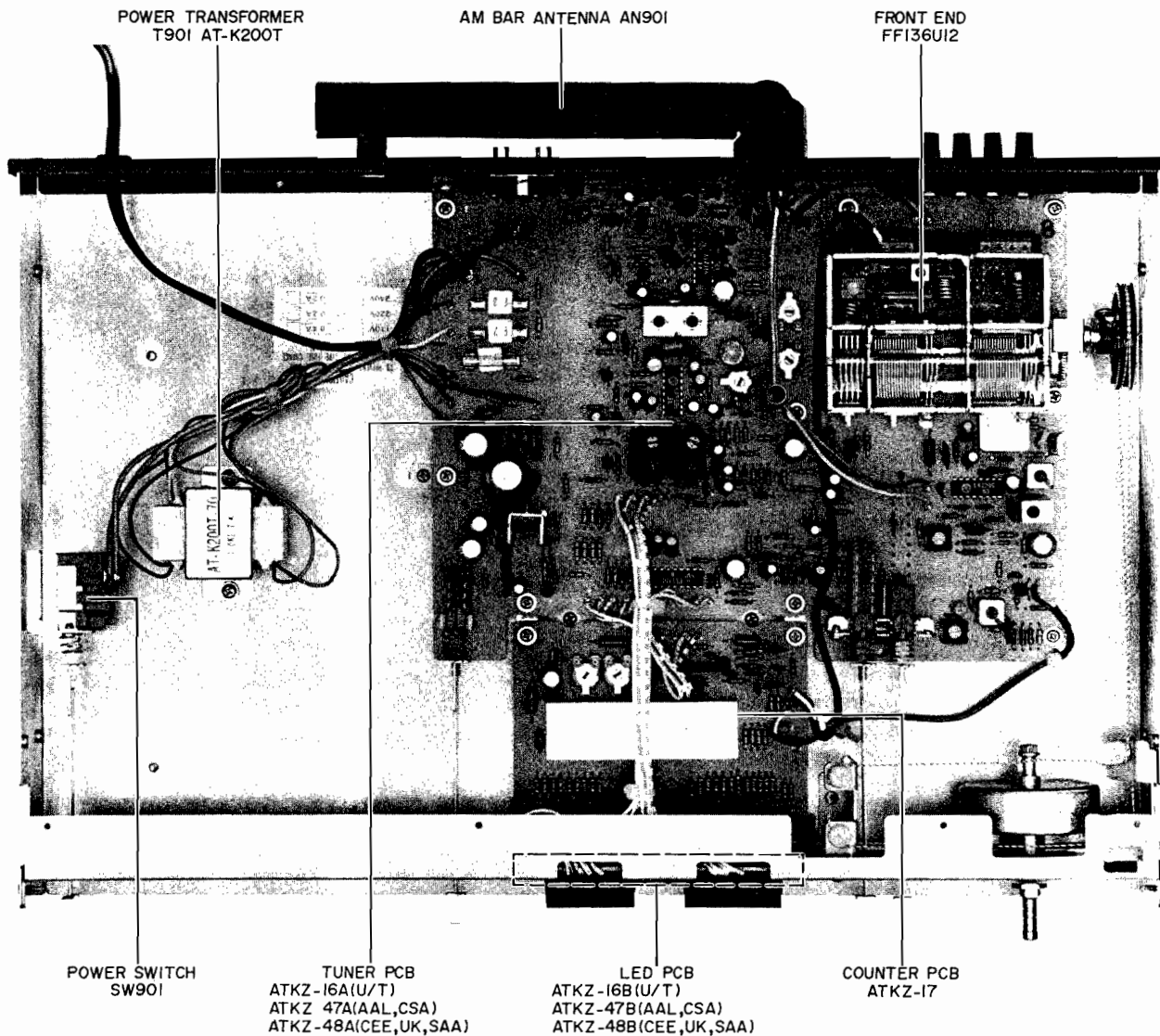

Fig. 6 Top View

## V. VOLTAGE CONVERSION

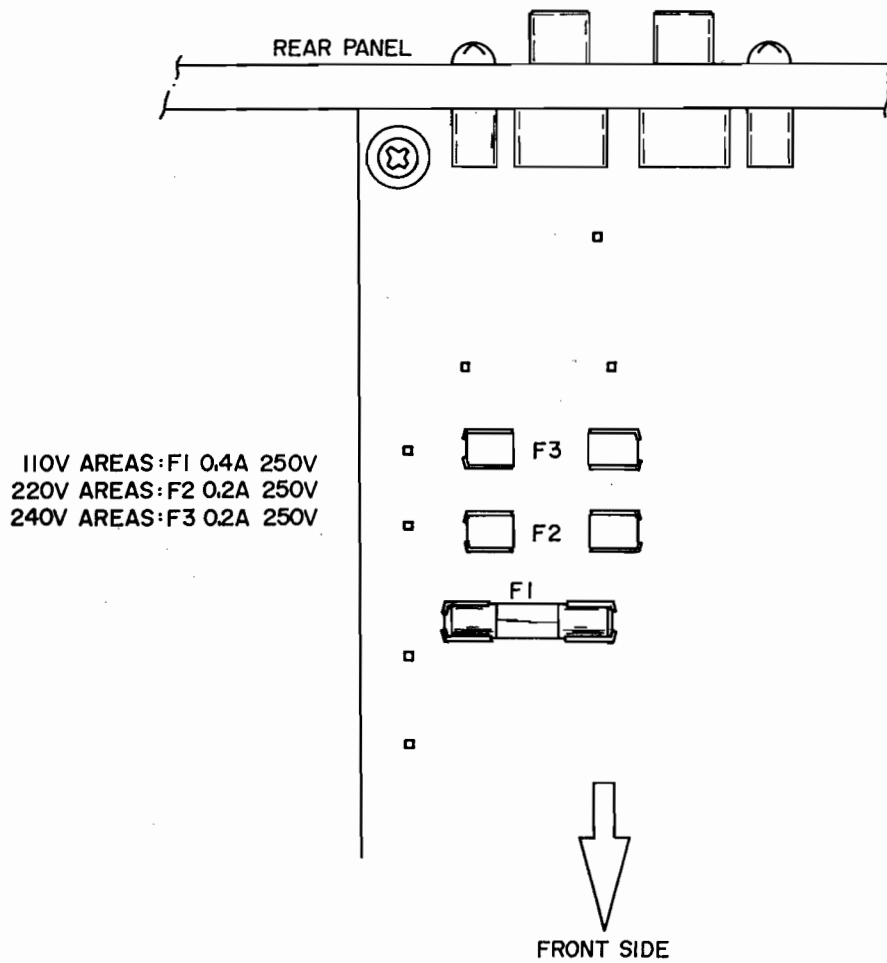

Fig 7 Voltage Conversion (U/T Model Only)

Models for Canada, U.S.A., Europe, UK and Australia are not equipped with this facility.

Each machine is preset at the factory according to destination but some machines can be set to 110 V, 220 V, or 240 V as required.

If voltage change is necessary, this can be accomplished as follows.

- 1) Disconnect AC Power Cord.
- 2) Loosen holding screws and remove upper case.
- 3) Remove existing Line Voltage Fuse and insert required Line Voltage Fuse in proper fuse holder. Follow markings explicitly.

# VI. TUNER ADJUSTMENTS

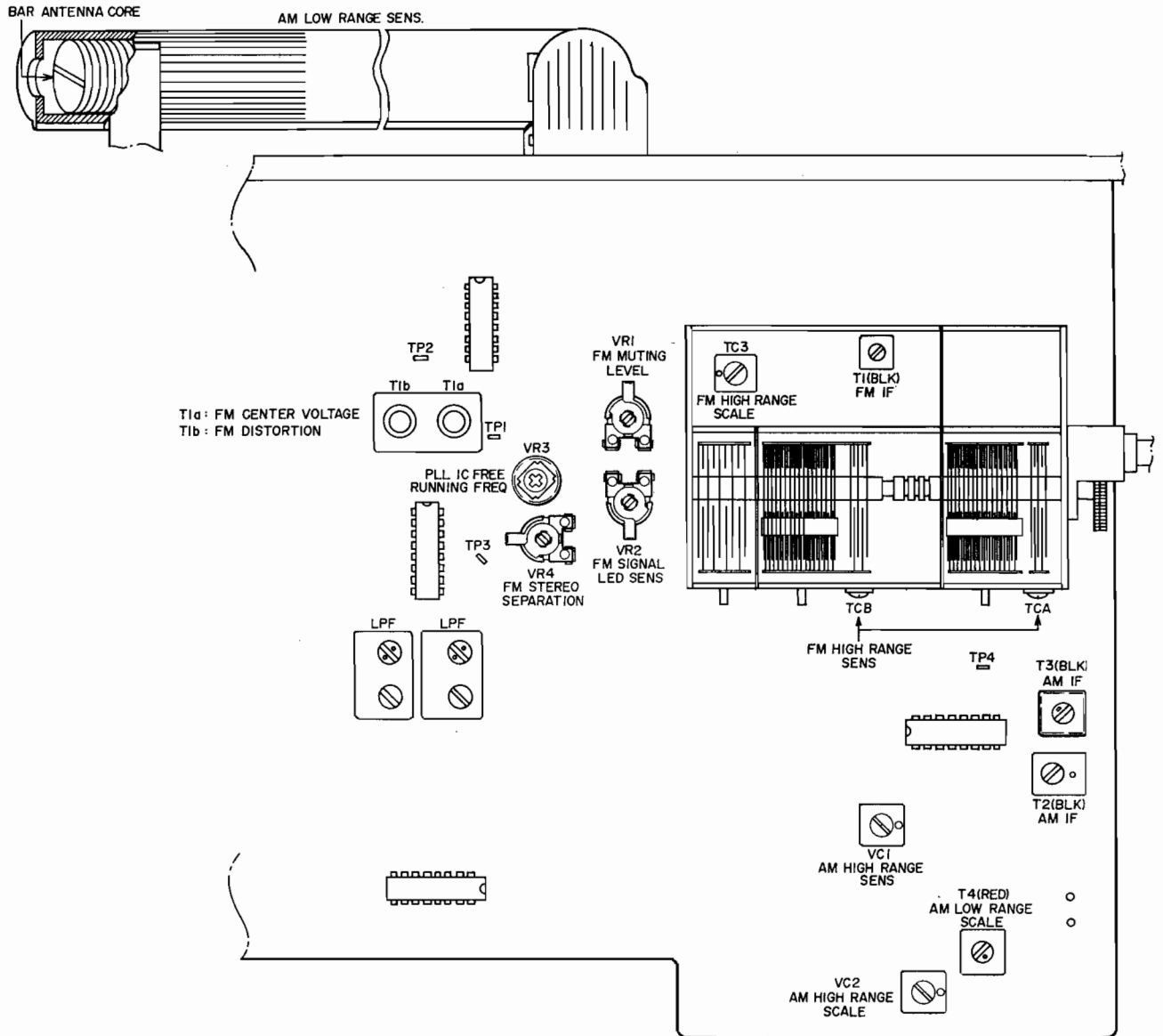

Fig. 8 Tuner P.C Board

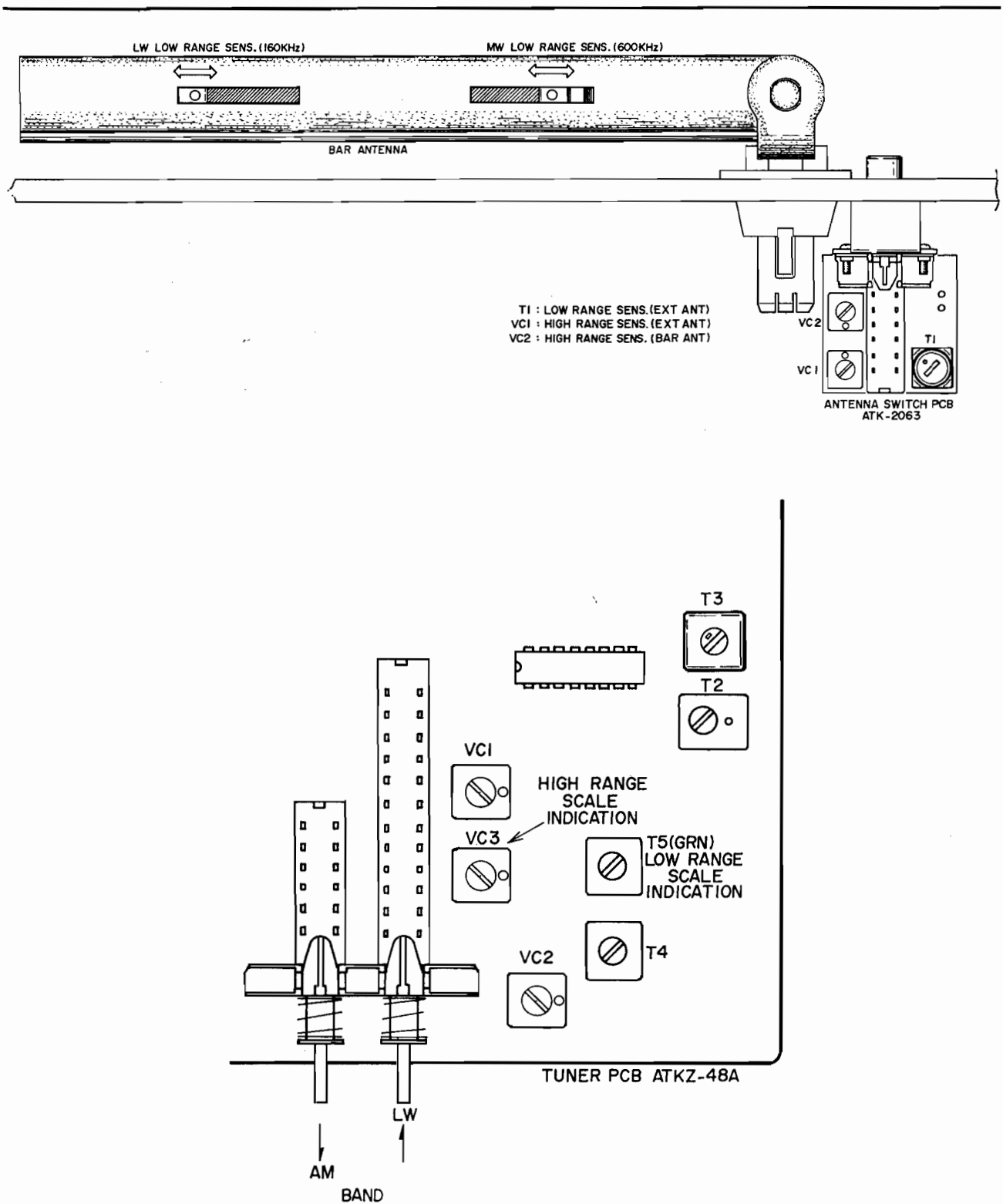

Fig. 9 Tuner P.C Board ATKZ-48A and Antenna Switch P.C Board ATK-2063 (AT-K11L and AT-K22L)

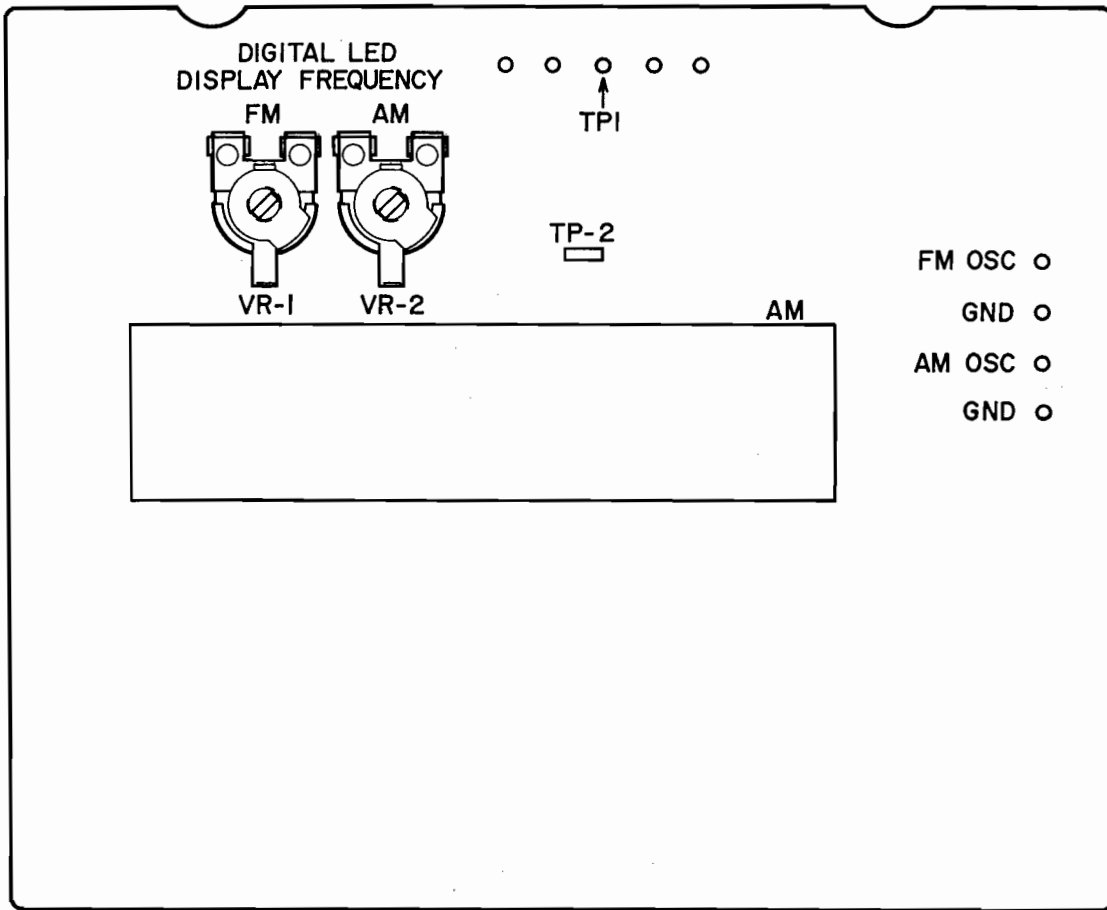

Fig. 10 Counter P.C Board ATKZ-17

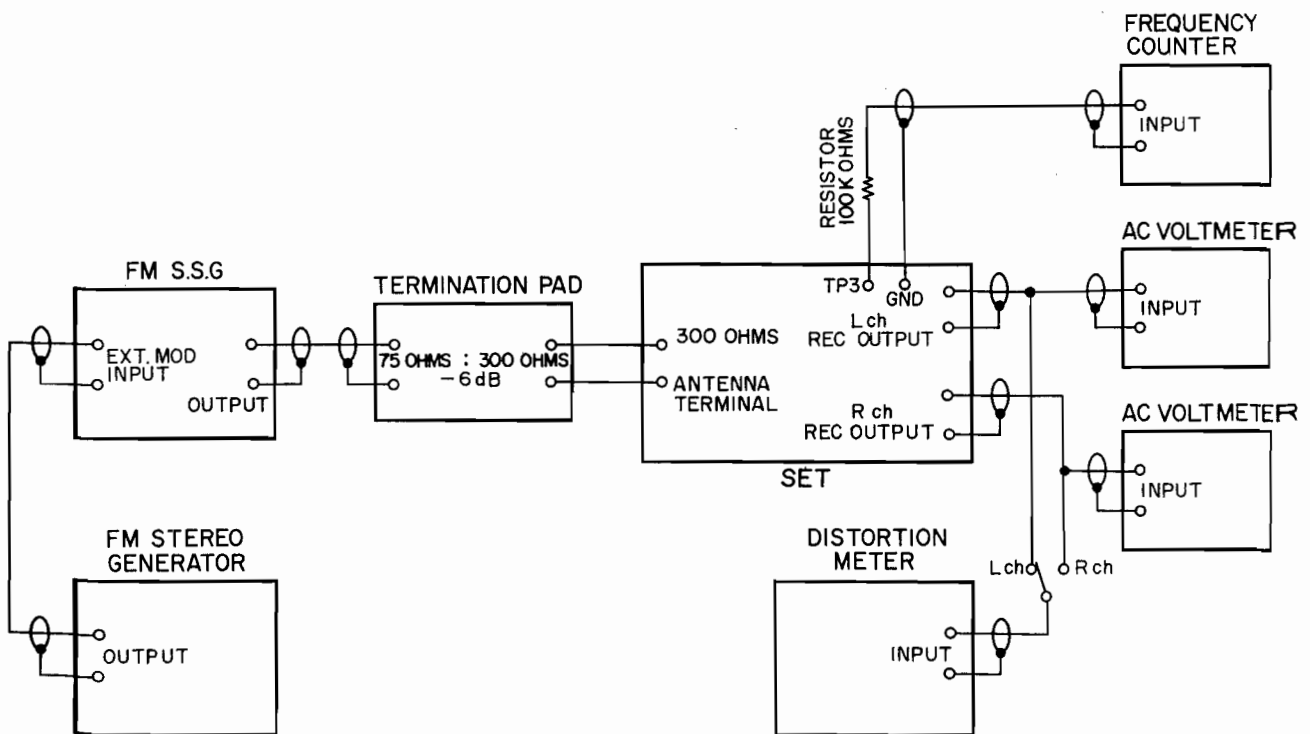

Fig. 11 Instrument Connections

## 1. FM SECTION ADJUSTMENTS (Refer to Figs. 8, 10, 11)

Unless otherwise specified, use the adjustment points provided on the Tuner P.C Board (Fig. 8).

Step	Adjustment Item	Adjustment Point	Result	Remarks
1	Front-end IF Coil	T1 (BLK) (Front-end)	Maximum Noise Level	BAND switch to FM, and MODE to MONO. Turns only noise without interference from broadcasting.
2	Center Voltage	T1-a	Centered Tuning Meter Indication	Connect a Center Tuning Meter between TP1 and TP2. (See Note 1) Turns only noise without interference from broadcasting.
3	Distortion Factor	T1-b	Distortion Factor: Less than 0.1%	98 MHz, 60 dB, 1 kHz (mono 100%) input. Less than 0.1% in both channels.
4				Readjust in Steps 2 and 3.
5	Confirmation of Output Level •		0 dBm $\pm$ 3 dB	98 MHz, 60 dB, 1 kHz (mono 100%) input.
6	Signal LED Sensitivity	VR2 (30 K)		98 MHz, 50 dB input. Adjust VR2 to a point where 5th LED of SIGNAL LED lights up. (See Note 2)
7	Digital LED Display Frequency (AT-K22/L Only)	VR1 (10 KB) Counter P.C Board (Fig. 10)		Apply a 98 MHz, 60 dB input. Short TP1 to GND on the Counter P.C Board. Adjust VR1 until 3rd numeral display becomes stable position. (See Note 3)
8	High Range Scale Indication	TC3 (Front-end)	(Model AT-K11/L) Maximum Output Minimum Distortion Factor	108 MHz, 60 dB, 1 kHz (mono 100%) input. Scale indicator to 108 MHz. Error: Within $\pm$ 250 kHz.
			(Model AT-K22/L)	Turn tuning knob fully clockwise. Display 108 MHz by adjusting TC3.
9	High Range Sensitivity	TCA, TCB (Front-end)	Distortion Factor: Less than 3%	MODE switch to MONO. 108 MHz, Less than 6 dB, 1 kHz (mono) input.
10	Confirmation of Low Range Sensitivity		Distortion Factor: Less than 3%	88 MHz, Less than 6 dB, 1 kHz (mono) input. (See Notes 4 and 5)
11	Muting Level	VR1 (30 K)	22 dB $\pm$ 6 dB	MODE switch to STEREO. 98 MHz, 22 dB, 1 kHz (mono 100%) input. Adjust VR1 until the output signal is reduced to zero. Vary the SSG output by $\pm$ 6 dB and check muting operation.
12	PLL IC Free Running Frequency	VR3 (4.7 K)	19 kHz $\pm$ 50 Hz	Connect a Frequency Counter between TP3 and GND on the Tuner P.C Board. (See Note 6)
13	Stereo Separation (Left→Right)	VR4 (500)	More than 45 dB	98 MHz, 60 dB, 1 kHz (stereo 100%) Lch input. Minimum output of Rch.
14	Stereo Separation (Right→Left)	VR4 (500)	More than 45 dB	98 MHz, 60 dB, 1 kHz (stereo 100%) Rch input. Minimum output of Lch.

Step	Adjustment Item	Adjustment Point	Result	Remarks
15	Confirmation of Stereo Distortion Factor		Distortion Factor: Less than 0.15%	100 MHz, 60 dB, 1 kHz (stereo 100%) input. If distortion exceeds 0.15%, first check according to Steps 2, 3, 12, 13 and 14, and then re-adjust according to Step 1.

Notes:

1. For the Center Meter should be used the tuning meter and the like available as a part of the other models.
2. The 5th LED lights up at 50 dB but when the attenuator is decreased 2 dB it is extinguished.
- 3.

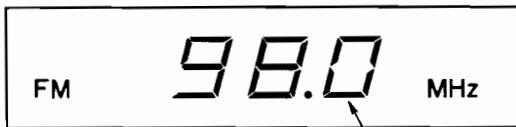

The optimum point of adjustment is when the indicated figure stops flashing.

4. When the specified sensitivity of 6 dB cannot be obtained at the two frequency points, 88 MHz and 108 MHz, repeat the adjustment as described in Step 9.
5. When the sensitivity distortion factor still does not comply with the data specifications, adjust by turning the Front-end IF Coil core, but not more than 1/2 turn.
6. When connecting a Frequency Counter, connect from TP via a 100 kohms resistor. (Refer to Fig. 11)



## 2. AM (AT-K11L and AT-K22L: MW) SECTION ADJUSTMENTS (Refer to Figs. 8, 9, 10, 12)

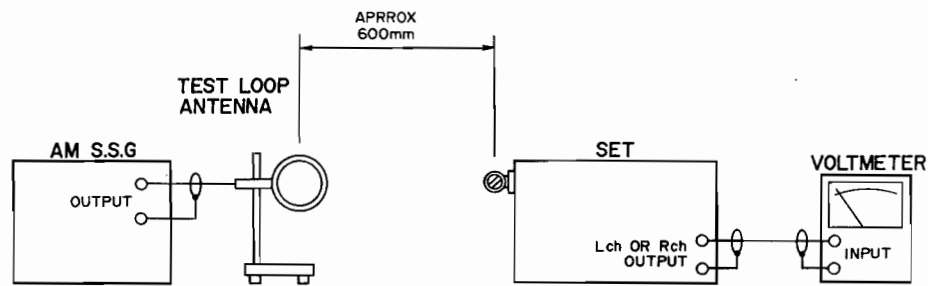

Fig. 12 Instrument Connections For AM(MW) Section Adjustments and Steps 1 to 4 of LW Section Adjustments

Unless otherwise specified, use the adjustment points provided on the Tuner P.C Board (Fig. 8)

\* Model AT-K11L and AT-K22L: ANTENNA SELECTOR to INT.

Step	Adjustment Item	Adjustment Point	Result	Remarks
1	Digital LED Display Frequency (AT-K22/L Only)	VR2 (10 KB) Counter P.C Board (Fig. 10)		Apply a 1,000 kHz, 50 dB input. Short TP1 to GND, and TP2 to GND on the Counter P.C Board. Adjust VR2 until 4th numeral display becomes stable position. (See Note 1)
2	AM IF Coil	T2 (BLK) T3 (BLK)	Maximum Output	1,000 kHz, 50 dB, 400 Hz (30%) input.
3	Low Range Scale Indication	T4 (RED)	(Model AT-K11/L) Maximum Output	530 kHz, 50 dB, 400 Hz (30%) input. Scale indicator to 530 kHz. Error: Within 2%
			(Model AT-K22/L)	Turn tuning knob fully counterclockwise. Display 515 kHz by adjusting T4.
4	High Range Scale Indication	VC2	(Model AT-K11/L) Maximum Output	1,600 kHz, 50 dB, 400 Hz (30%) input. Scale indicator to 1,600 kHz. Error: Within 2%
			(Model AT-K22/L)	Turn tuning knob fully clockwise. Display 1,650 kHz by adjusting VC2.
5	Low Range Sensitivity	Bar Antenna Core AT-K11, K22: Fig. 8 AT-K11L, K22L: Fig. 9	Maximum Output Distortion Factor: Less than 10%	600 kHz, 50 dB, 400 Hz (30%) input.
6	High Range Sensitivity	VC1	Maximum Output Distortion Factor: Less than 10%	1,600 kHz, 50 dB, 400 Hz (30%) input.

Notes:

1.



The optimum point of adjustment is when the indicated figure stops flashing.

2. For best result, repeat Steps 2 through 6 two or three times.

### 3. LW SECTION ADJUSTMENTS (AT-K11L and AT-K22L Only; Refer to Figs. 9, 12, 13)

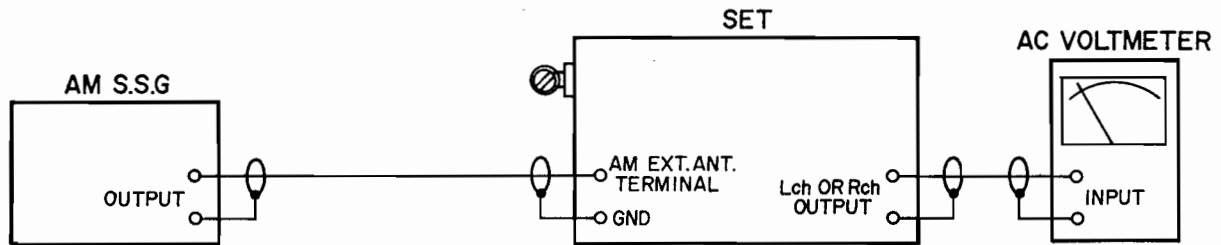

Fig. 13 Instrument Connections For Steps 5 and 6 of LW Section Adjustments

Unless otherwise specified, use the adjustment points provided on the Tuner P.C Board (Fig. 9).

- \* BAND SELECTOR to LW
- ANTENNA SELECTOR to INT.

Step	Adjustment Item	Adjustment Point	Result	Remarks
1	High Range Scale Indication	VC3	(AT-K11L) Maximum Output	340 kHz, 50 dB, 400 Hz (30%) input. Scale indicator to 340 kHz. Error: Within 2% (Refer to Fig. 12)
			(AT-K22L)	Turn tuning knob fully clockwise. Display 350 kHz by adjusting VC 3.
2	Low Range Scale Indication	T5 (GRN)	(AT-K11L) Maximum Output	150 kHz, 50 dB, 400 Hz (30%) input. Scale indicator to 150 kHz. Error: Within 2% (Refer to Fig. 12)
			(AT-K22L)	Turn tuning knob fully counter-clockwise. Display 135 kHz by adjusting T5.
3	Low Range Sensitivity (Bar Antenna)	Bar Antenna Core (Fig. 9)	Maximum Output Distortion Factor: Less than 10%	160 kHz, 50 dB, 400 Hz (30%) input. (Refer to Fig. 12)
4	High Range Sensitivity (Bar Antenna)	VC2 Antenna Switch P.C Board (Fig. 9)	Maximum Output Distortion Factor: Less than 10%	300 kHz, 50 dB, 400 Hz (30%) input. (Refer to Fig. 12)
5	Low Range Sensitivity (EXT. Antenna)	T1 Antenna Switch P.C Board (Fig. 9)	Maximum Output Distortion Factor: Less than 10%	ANTENNA SELECTOR to EXT. 160 kHz, 20 dB, 400 Hz (30%) input. (Refer to Fig. 13)
6	High Range Sensitivity (EXT. Antenna)	VC1 Antenna Switch P.C Board (Fig. 9)	Maximum Output Distortion Factor: Less than 10%	300 kHz, 20 dB, 400 Hz (30%) input. (Refer to Fig. 13)

# VII. TUNING CORD THREADING

## 1. MODEL AT-K11/L

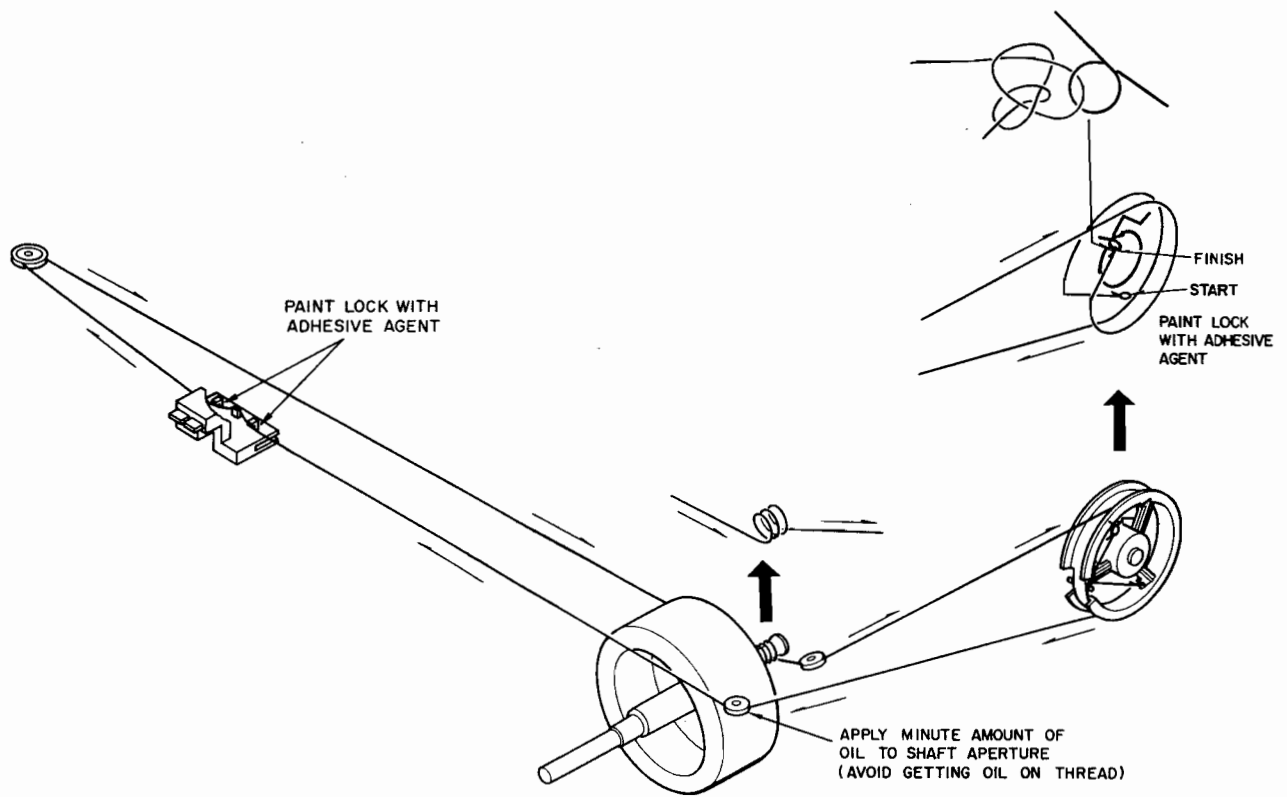

Fig. 14 Tuning Cord Threading (AT-K11/L)

## 2. MODEL AT-K22/L

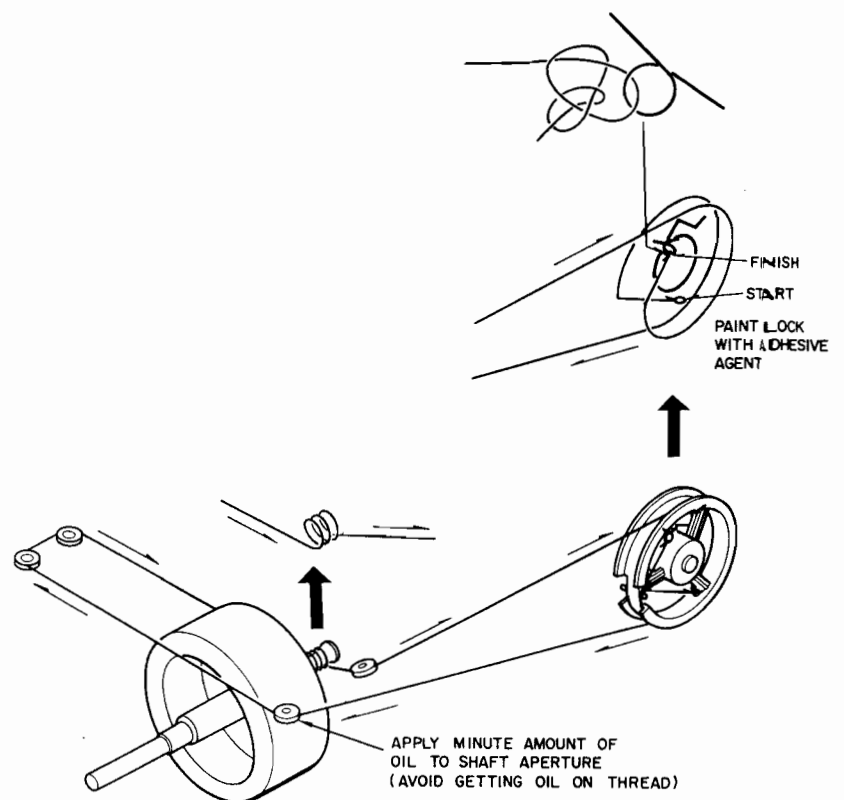

Fig. 15 Tuning Cord Threading (AT-K22/L)

## VIII. CLASSIFICATION OF VARIOUS P.C BOARDS

### 1. P.C BOARD TITLES AND IDENTIFICATION NUMBERS

#### 1) Model AT-K11

P.C Board Title	P.C Board Number
Tuner P.C Board	ATKZ-16A (U/T) ATKZ-47A (AAL, CSA) ATKZ-48A (CEE, SAA)
LED P.C Board	ATKZ-16B (U/T) ATKZ-47B (AAL, CSA) ATKZ-48B (CEE, SAA)

#### 2) Model AT-K11L

P.C Board Title	P.C Board Number
Tuner P.C Board	ATKZ-48A
LED P.C Board	ATKZ-48B
Antenna Switch P.C Board	ATK-2063

#### 3) Model AT-K22

P.C Board Title	P.C Board Number
Tuner P.C Board	ATKZ-16A (U/T) ATKZ-47A (AAL, CSA) ATKZ-48A (CEE, SAA)
LED P.C Board	ATKZ-16B (U/T) ATKZ-47B (AAL, CSA) ATKZ-48B (CEE, SAA)
Counter P.C Board	ATKZ-17

#### 4) Model AT-K22L

P.C Board Title	P.C Board Number
Tuner P.C Board	ATKZ-48A
LED P.C Board	ATKZ-48B
Counter P.C Board	ATKZ-17
Antenna Switch P.C Board	ATK-2063

## 2. COMPOSITION OF VARIOUS P.C BOARDS

1) MODEL AT-K11 Tuner P.C Board ATKZ-16A (U/T), ATKZ-47A (AAL, CSA), ATKZ-48A (CEE, SAA) and LED P.C Board ATKZ-16B (U/T), ATKZ-47B (AAL, CSA), ATKZ-48B (CEE, SAA)

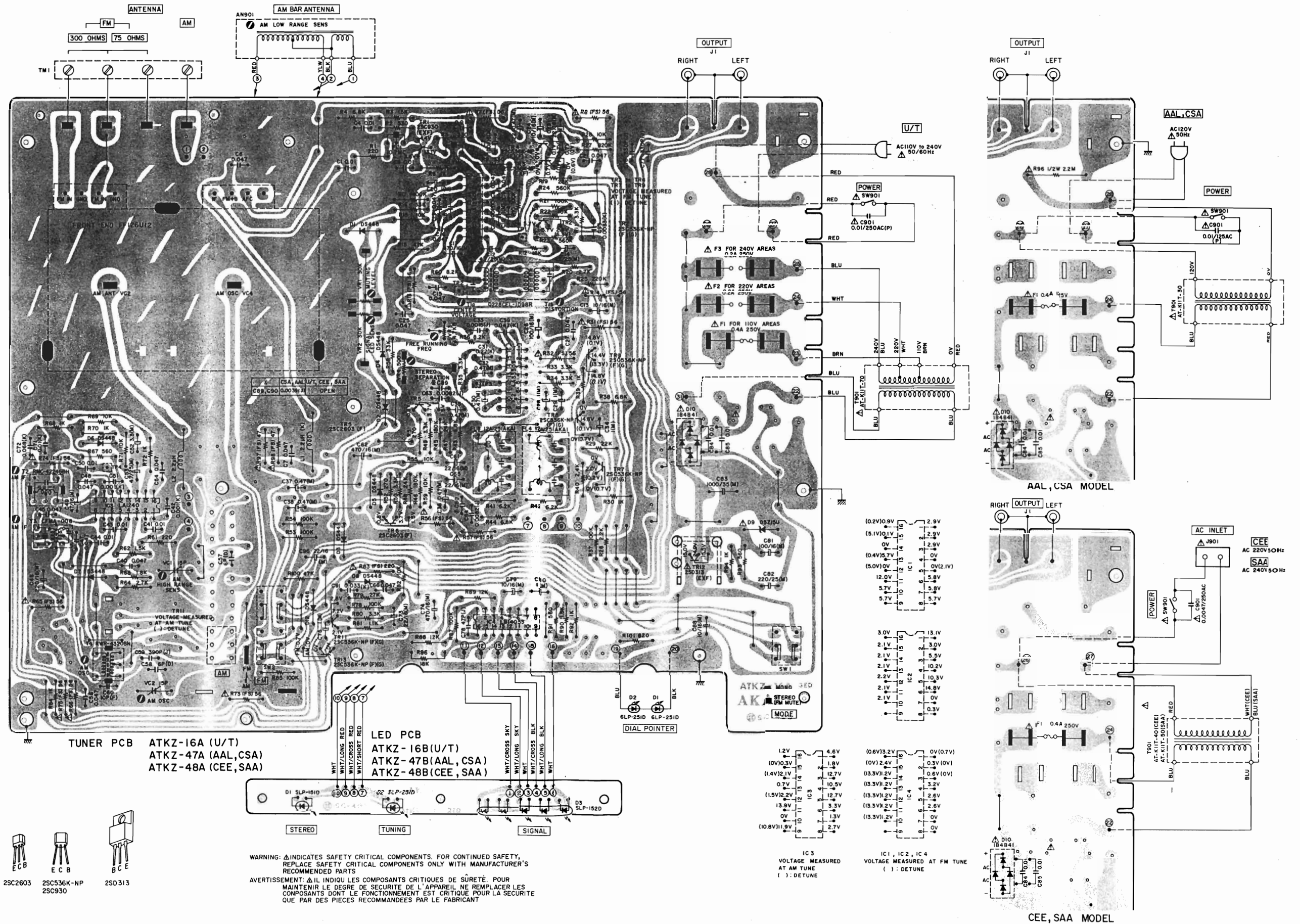

2) MODEL AT-K11L Tuner P.C Board ATKZ-48A and LED P.C Board ATKZ-48B

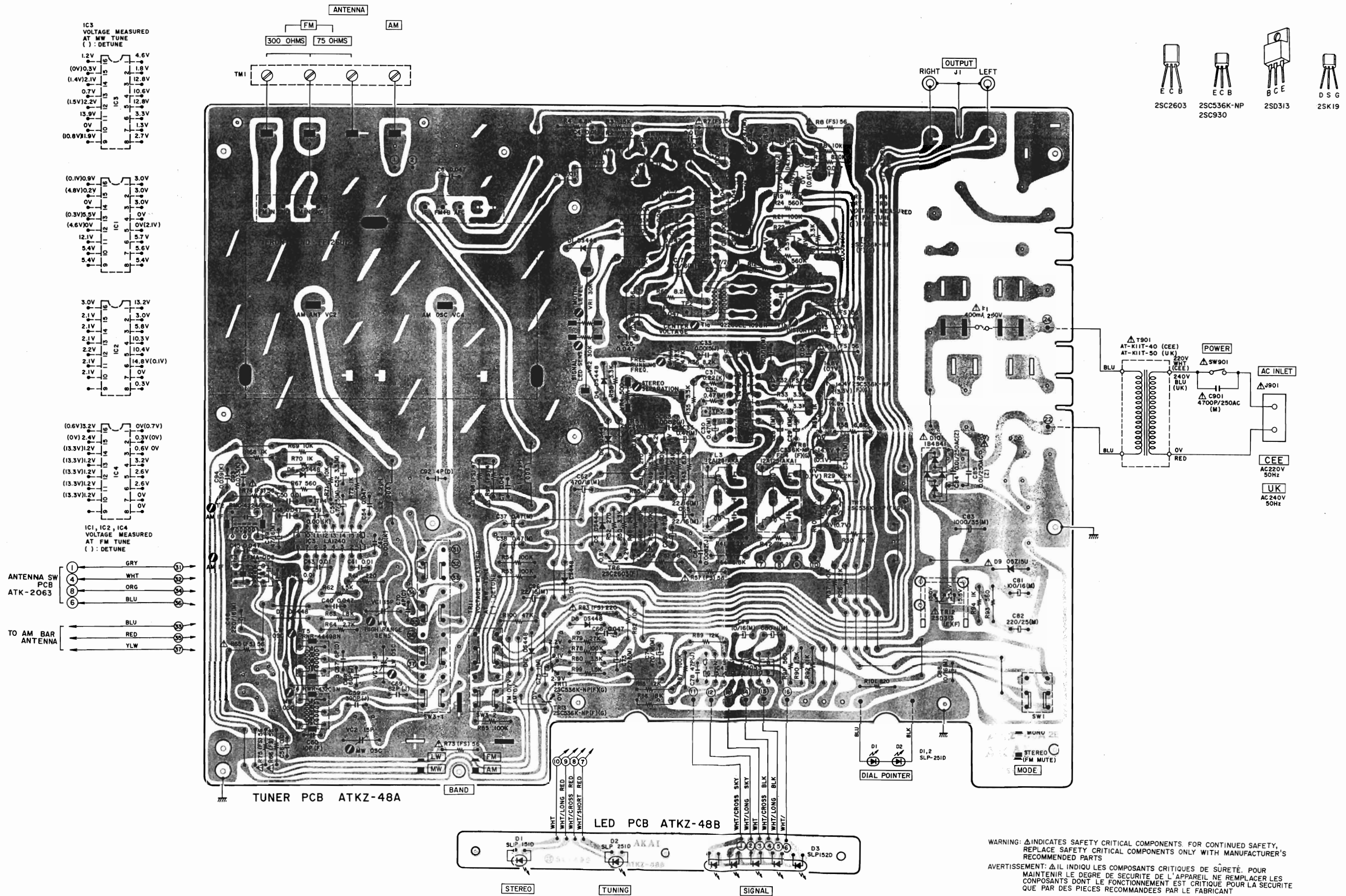

3) MODEL AT-K22 Tuner P.C Board ATKZ-16A (U/T), ATKZ-47A (AAL, CSA), ATKZ-48B (CEE, SAA) and LED P.C Board ATKZ-16B (U/T), ATKZ-47B (AAL, CSA), ATKZ-48B (CEE, SAA)

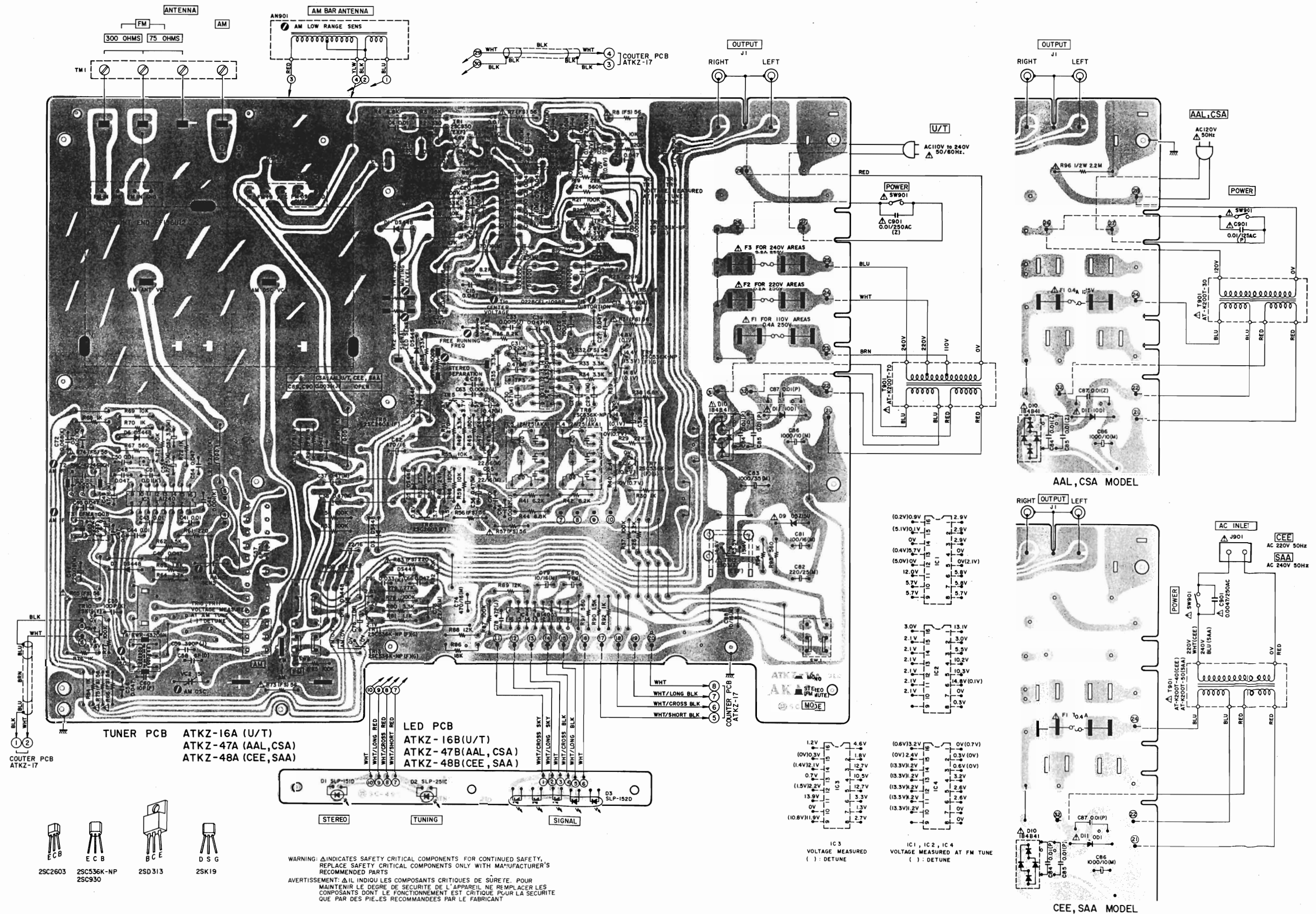

4) MODEL AT-K22L Tuner P.C Board ATKZ-48A and LED P.C Board ATKZ-48B

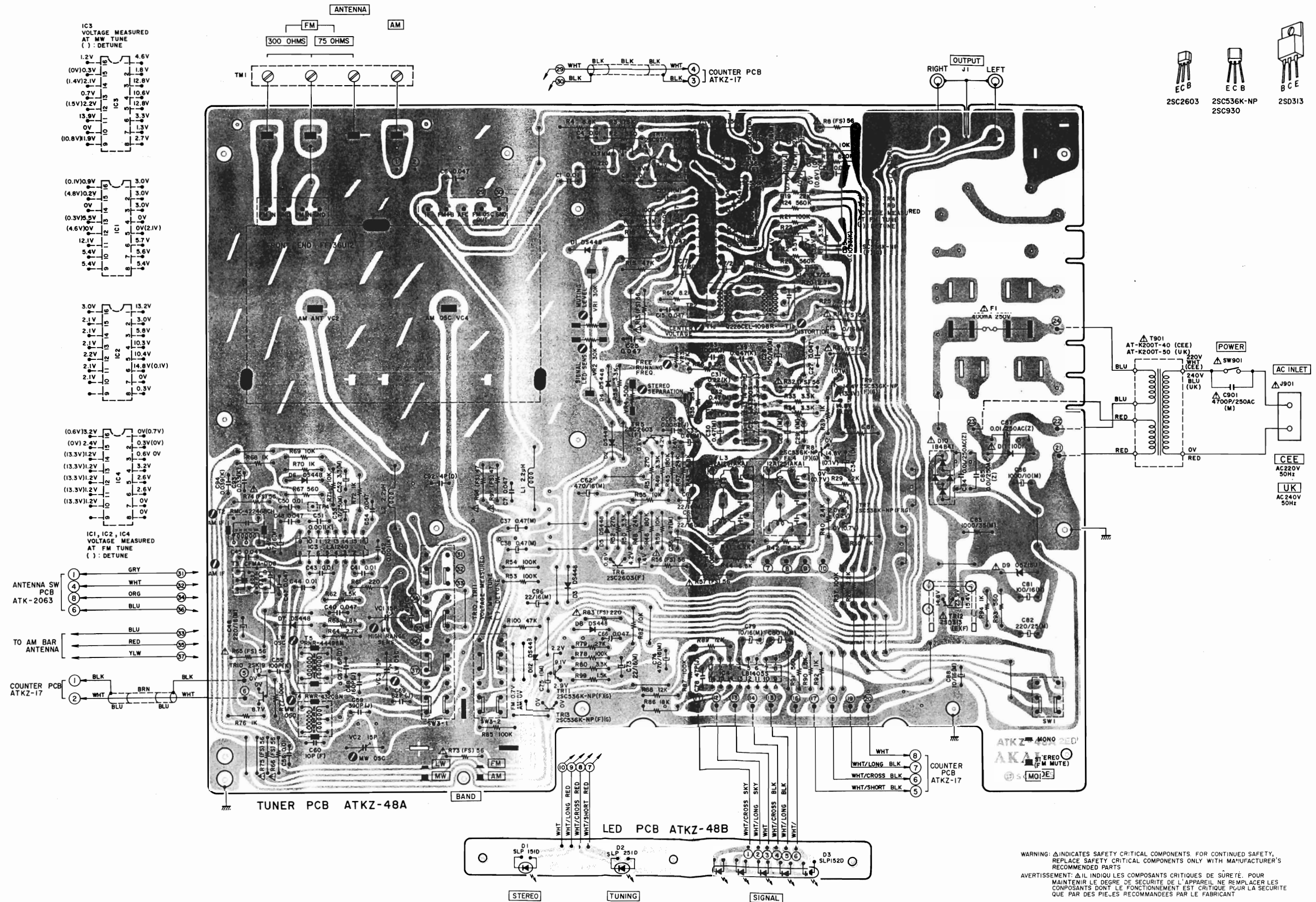



5) Counter P.C Board ATKZ-17 (AT-K22/L)

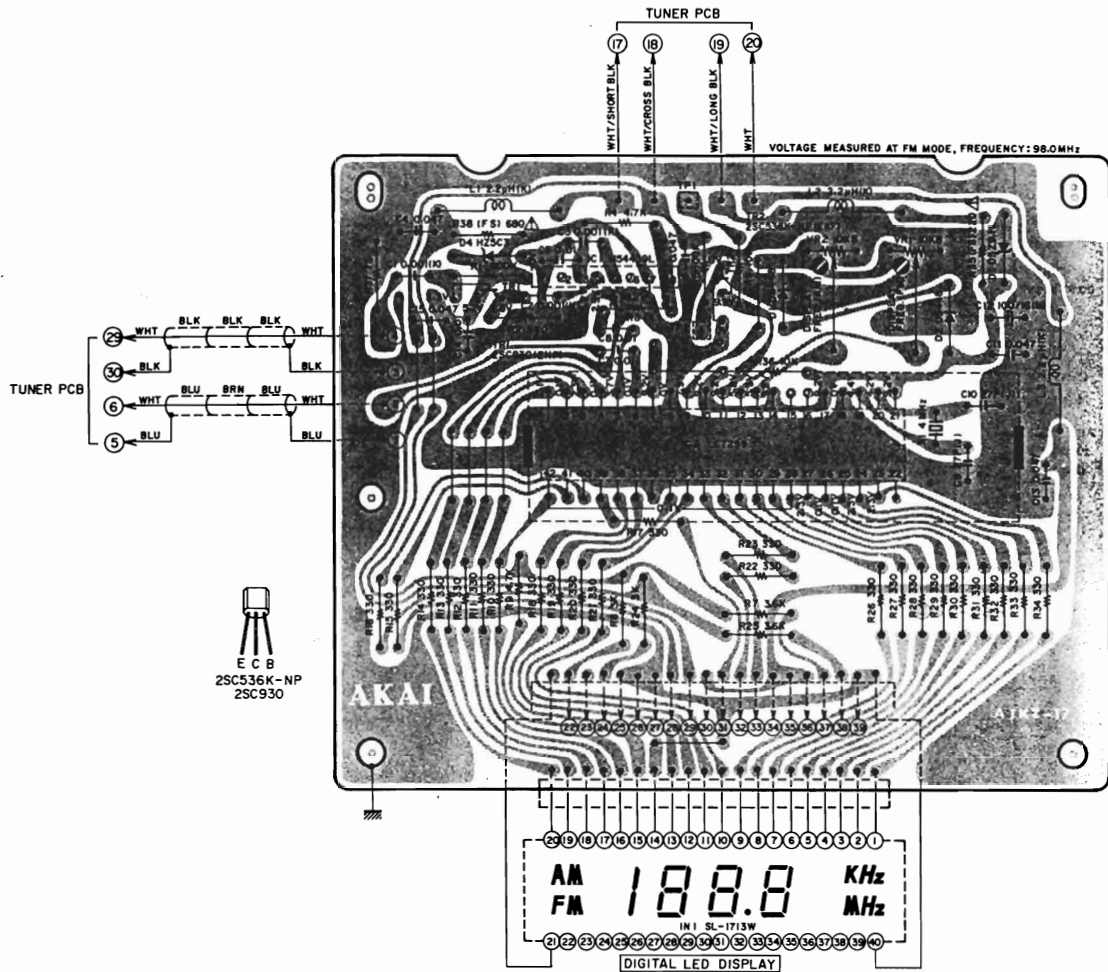

6) Antenna Switch P.C Board ATK-2063 (AT-K11L and AT-K22L)

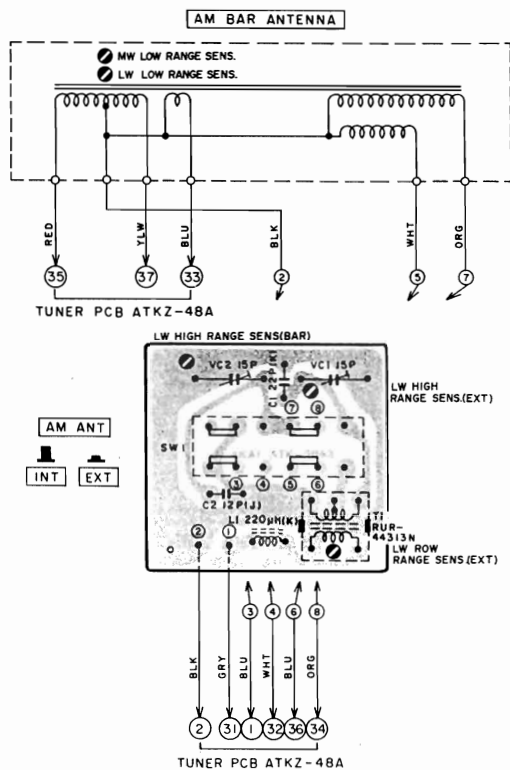

---

SECTION 2

**SERVICE MANUAL**

**MODEL AM-U11, AM-U22**

TABLE OF CONTENTS

<b>I. TECHNICAL DATA</b> .....	<b>28</b>
1. MODEL AM-U11 .....	28
2. MODEL AM-U22 .....	29
<b>II. DISMANTLING OF UNIT</b> .....	<b>30</b>
1. MODEL AM-U11 .....	30
2. MODEL AM-U22 .....	31
<b>III. CONTROLS</b> .....	<b>32</b>
1. MODEL AM-U11 .....	32
2. MODEL AM-U22 .....	33
<b>IV. PRINCIPAL PARTS LOCATION</b> .....	<b>34</b>
1. MODEL AM-U11 .....	34
2. MODEL AM-U22 .....	35
<b>V. VOLTAGE CONVERSION</b> .....	<b>36</b>
1. MODEL AM-U11 .....	36
2. MODEL AM-U22 .....	36
<b>VI. AMPLIFIER ADJUSTMENT</b> .....	<b>37</b>
1. POWER METER SENSITIVITY ADJUSTMENT .....	38
<b>VII. CLASSIFICATION OF VARIOUS P.C BOARDS</b> .....	<b>39</b>
1. P.C. BOARD TITLES AND IDENTIFICATION NUMBERS .....	39
2. COMPOSITION OF VARIOUS P.C BOARDS .....	40

For basic adjustments, measuring methods, and operating principles, refer to GENERAL TECHNICAL MANUAL.

# I. TECHNICAL DATA

## 1. MODEL AM-U11

### POWER AMPLIFIER SECTION

RATED POWER OUTPUT	20 watts per channel, minimum RMS, at 8 ohms from 40 Hz to 20,000 Hz with no more than 0.3% total harmonic distortion.
POWER BANDWIDTH (IHF -3 dB)	10 Hz to 40 kHz/8 ohms (Total harmonic distortion: 0.3%)
SIGNAL TO NOISE RATIO (IHF-A)	
PHONO	70 dB
AUX	90 dB
RESIDUAL NOISE (8 OHMS)	1.3 mV
CHANNEL SEPARATION (IHF)	Better than 50 dB at 1 kHz
DAMPING FACTOR	More than 30 (1 kHz, 8 ohms)
OUTPUT	
SPEAKERS	4 to 16 ohms
HEADPHONES	4 to 16 ohms

### PREAMPLIFIER SECTION

INPUT SENSITIVITY/IMPEDANCE	
PHONO	3 mV/47 kohms
AUX	150 mV/100 kohms
TUNER	150 mV/100 kohms
TAPE	150 mV/100 kohms
OUTPUT LEVEL/IMPEDANCE	
TAPE REC	(PIN) 150 mV/2 kohms (DIN) 30 mV/80 kohms
FREQUENCY RESPONSE	
PHONO	±1 dB (30 Hz to 15,000 Hz)
TUNER, AUX, TAPE	10 Hz to 50 kHz +0, -3 dB
TONE CONTROL	
BASS	±8 dB (100 Hz)
TREBLE	±6 dB (10 kHz)
LOUDNESS CONTROL (VOLUME SET AT -30 dB POSITION)	+10 dB (100 Hz), +6 dB (10 kHz)
PHONO MAX INPUT (1 kHz)	120 mV
POWER REQUIREMENT	120 V, 60 Hz for U.S.A. and Canada 220 V, 50 Hz for Europe except UK 240 V, 50 Hz for UK and Australia 110-120 V/220 V/240 V, 50/60 Hz internally switchable for the other countries.
DIMENSIONS	440(W) x 75(H) x 322(D) mm (17.3 x 3.0 x 12.7 inches)
WEIGHT	5.8 kg (12.8 lbs)

\* For improvement purposes, specifications and design are subject to change without notice.

## 2. MODEL AM-U22

### POWER AMPLIFIER SECTION

RATED POWER OUTPUT (2-channel Driven)	25 watts per channel, minimum RMS, at 8 ohms from 20 Hz to 20,000 Hz with no more than 0.05% total harmonic distortion.
POWER BANDWIDTH (IHF -3 dB)	8 Hz to 50 kHz/8 ohms (Total harmonic distortion: 0.1%)
SIGNAL TO NOISE RATIO (IHF-A) PHONO AUX	80 dB 95 dB
RESIDUAL NOISE (IHF-A)	180 $\mu$ V/8 ohms
CHANNEL SEPARATION (IHF)	Better than 55 dB at 1 kHz
DAMPING FACTOR	More than 50 (1 kHz, 8 ohms)
OUTPUT SPEAKERS HEADPHONE	4 to 16 ohms 4 to 16 ohms

### PREAMPLIFIER SECTION

INPUT SENSITIVITY/IMPEDANCE PHONO AUX TUNER TAPE	3 mV/47 kohms 150 mV/33 kohms 150 mV/33 kohms 150 mV/33 kohms
OUTPUT LEVEL/IMPEDANCE TAPE REC	150 mV/47 kohms
FREQUENCY RESPONSE PHONO (RIAA DEVIATION) TUNER, AUX, TAPE	$\pm$ 0.3 dB (20 Hz to 20,000 Hz) 6 Hz to 100 kHz +0 to -3 dB
TONE CONTROL BASS TREBLE	$\pm$ 8 dB (100 Hz) $\pm$ 8 dB (10 kHz)
PHONO MAX INPUT (1 kHz)	MM: 120 mV
POWER REQUIREMENT	120 V, 60 Hz for U.S.A. and Canada 220 V, 50 Hz for Europe except UK 240 V, 50 Hz for UK and Australia 110 V/220 V/240 V, 50/60 Hz internally switchable for other countries.
DIMENSIONS	440(W) x 78(H) x 290(D) mm (17.3 x 3.1 x 11.4 inches)
WEIGHT	5.6 kg (12.3 lbs)

\* For improvement purposes, specifications and design are subject to change without notice.

## II. DISMANTLING OF UNIT

### 1. MODEL AM-U11

In case of trouble, etc. necessitating dismantling, please dismantle in the order shown in the photographs. Reassemble in reverse order.

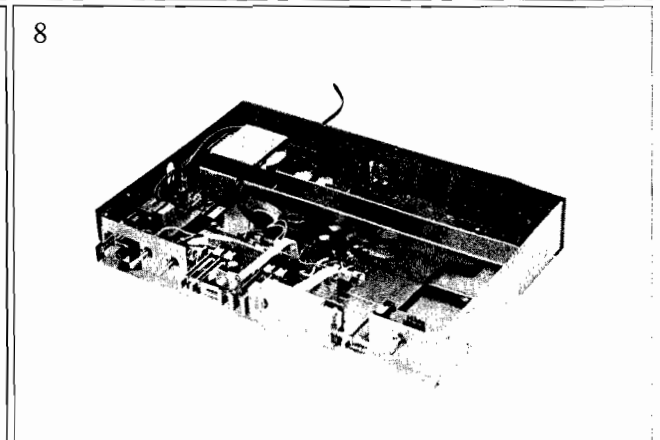
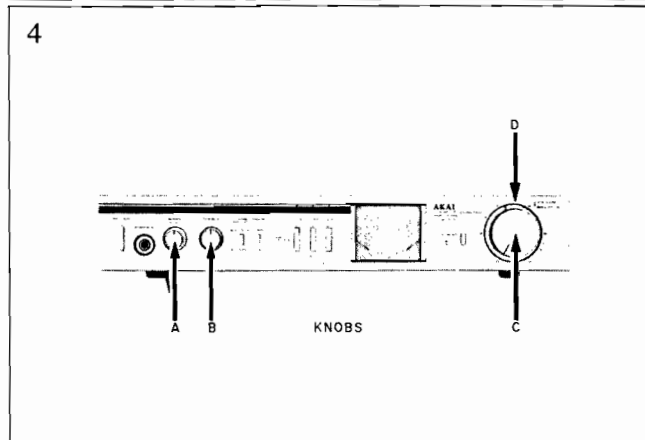
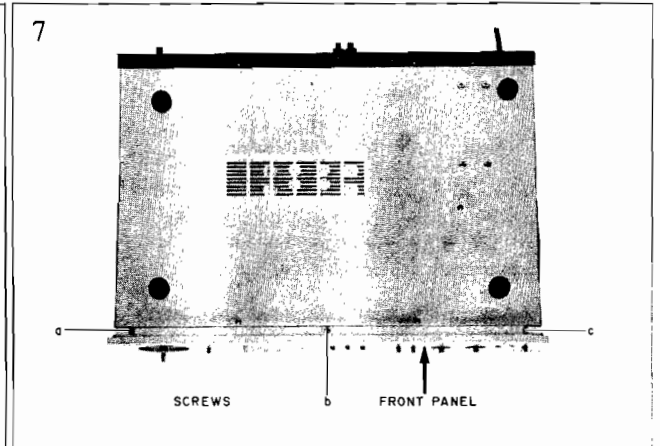
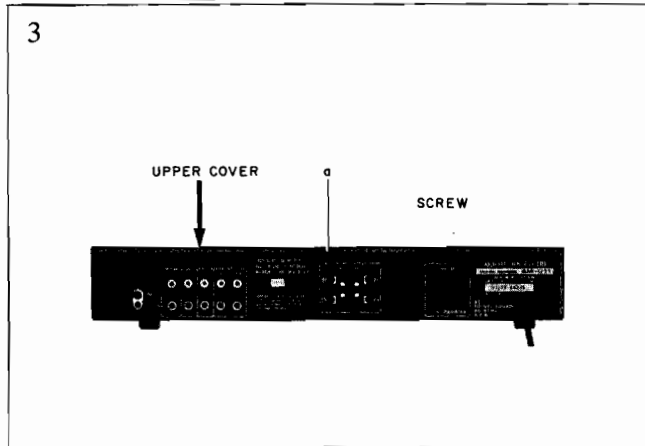
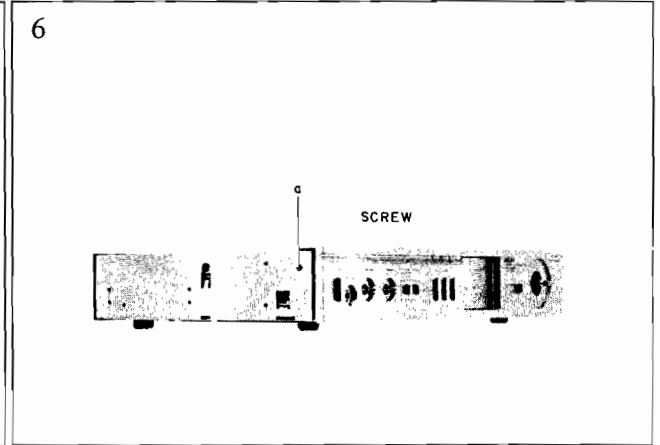
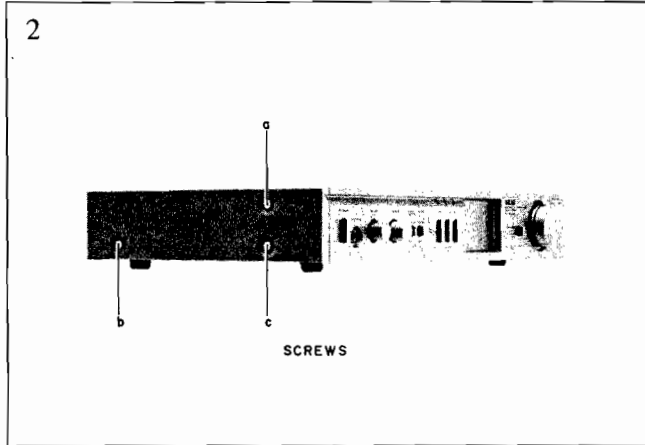
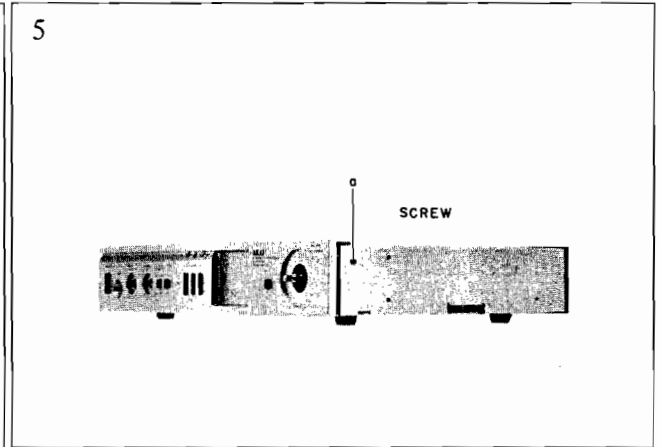
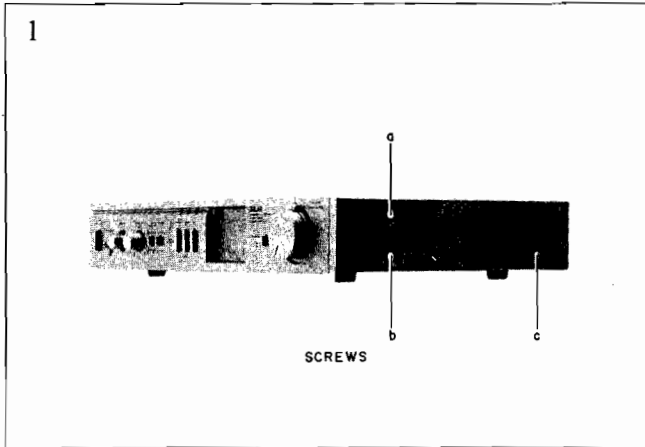

## 2. MODEL AM-U22

In case of trouble, etc. necessitating dismantling, please dismantle in the order shown in the photographs. Reassemble in reverse order.

4

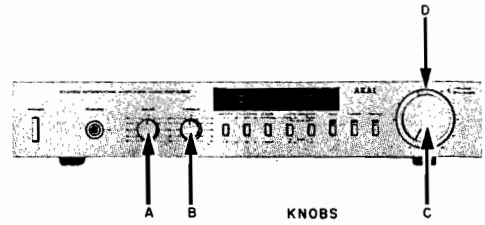

1

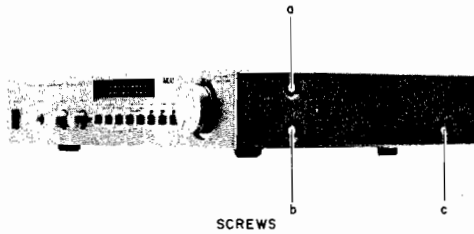

5

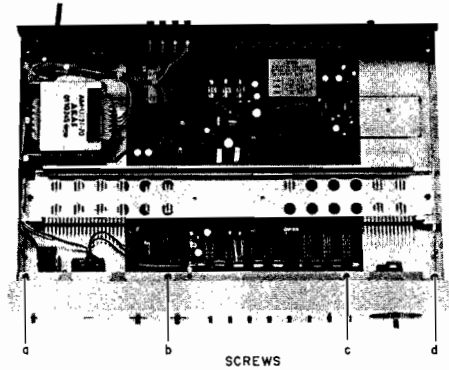

2

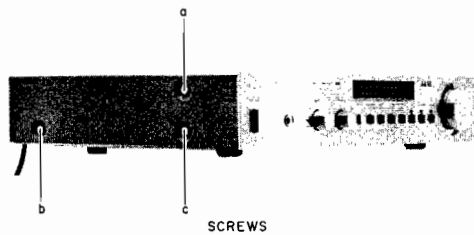

6

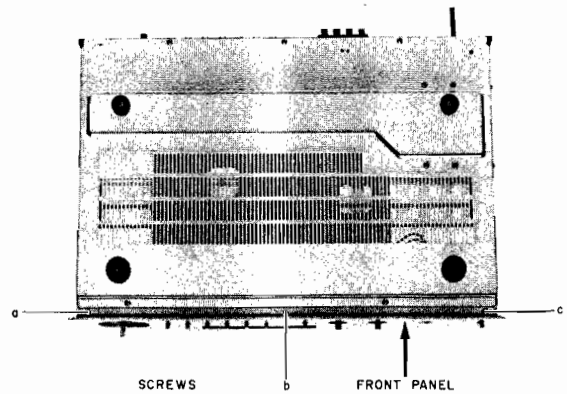

3

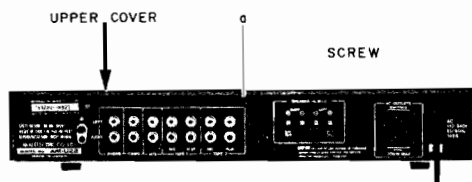

7

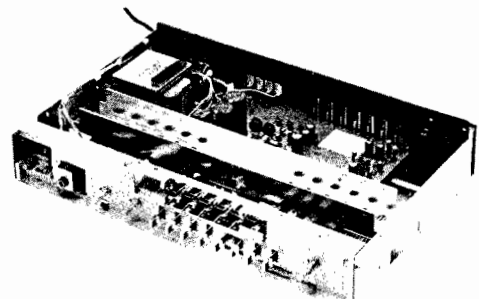

### III. CONTROLS

#### 1. MODEL AM-U11

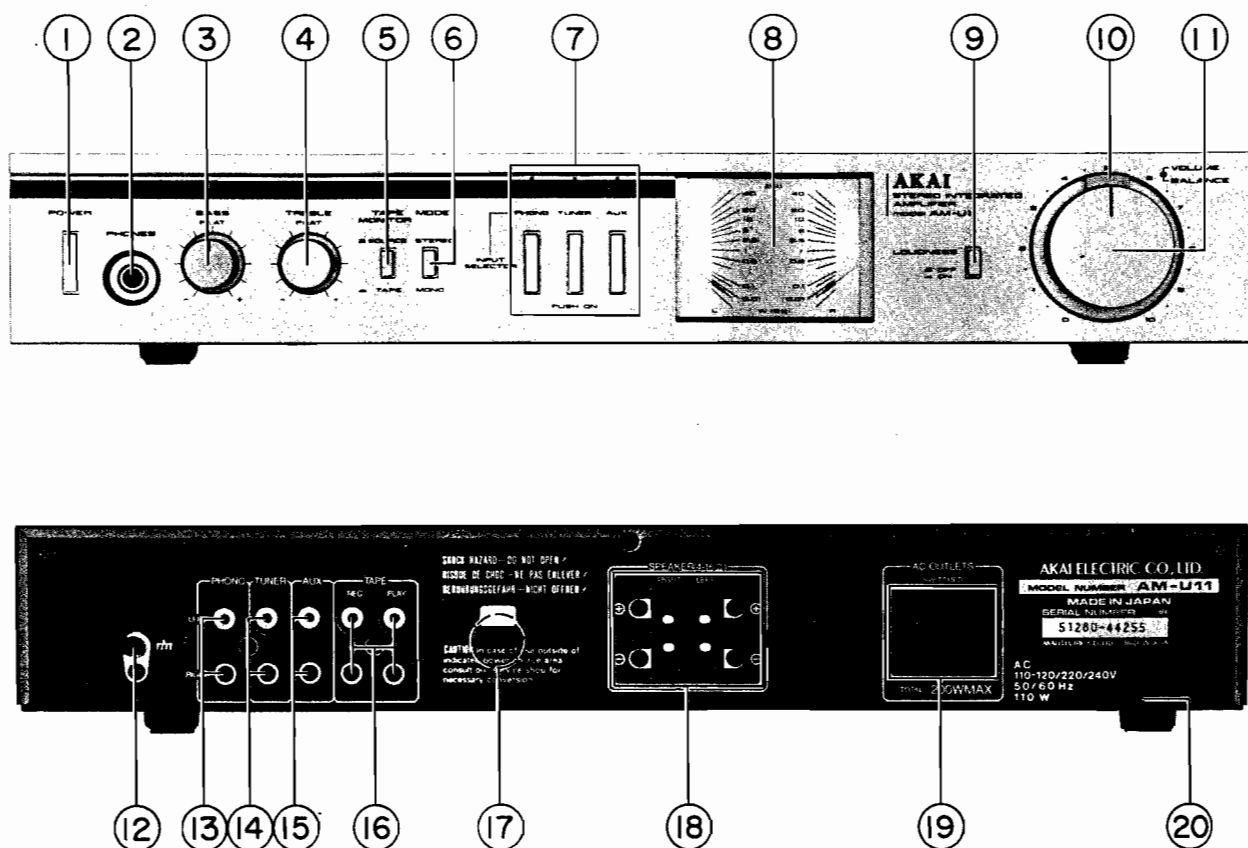

Fig. 1 Controls (AM-U11)

- |   |                                      |
|---|--------------------------------------|
| 1. POWER SWITCH                           | 11. VOLUME CONTROL                   |
| 2. HEADPHONE JACK (PHONES)                | 12. GROUND TERMINAL ( $\text{///}$ ) |
| 3. BASS CONTROL                           | 13. PHONO JACKS                      |
| 4. TREBLE CONTROL                         | 14. TUNER JACKS                      |
| 5. TAPE MONITOR SELECTOR                  | 15. AUX JACKS                        |
| 6. MODE SELECTOR                          | 16. TAPE SYSTEM REC/PLAY JACKS       |
| 7. INPUT SELECTOR SWITCHES AND INDICATORS | 17. DIN JACK (CEE, UK, SAA ONLY)     |
| 8. OUTPUT METER                           | 18. SPEAKER TERMINALS                |
| 9. LOUDNESS SWITCH                        | 19. AC OUTLETS (U/T, AAL, CSA ONLY)  |
| 10. STEREO BALANCE CONTROL                | 20. AC CORD (CEE, UK, SAA: AC INLET) |

## 2. MODEL AM-U22

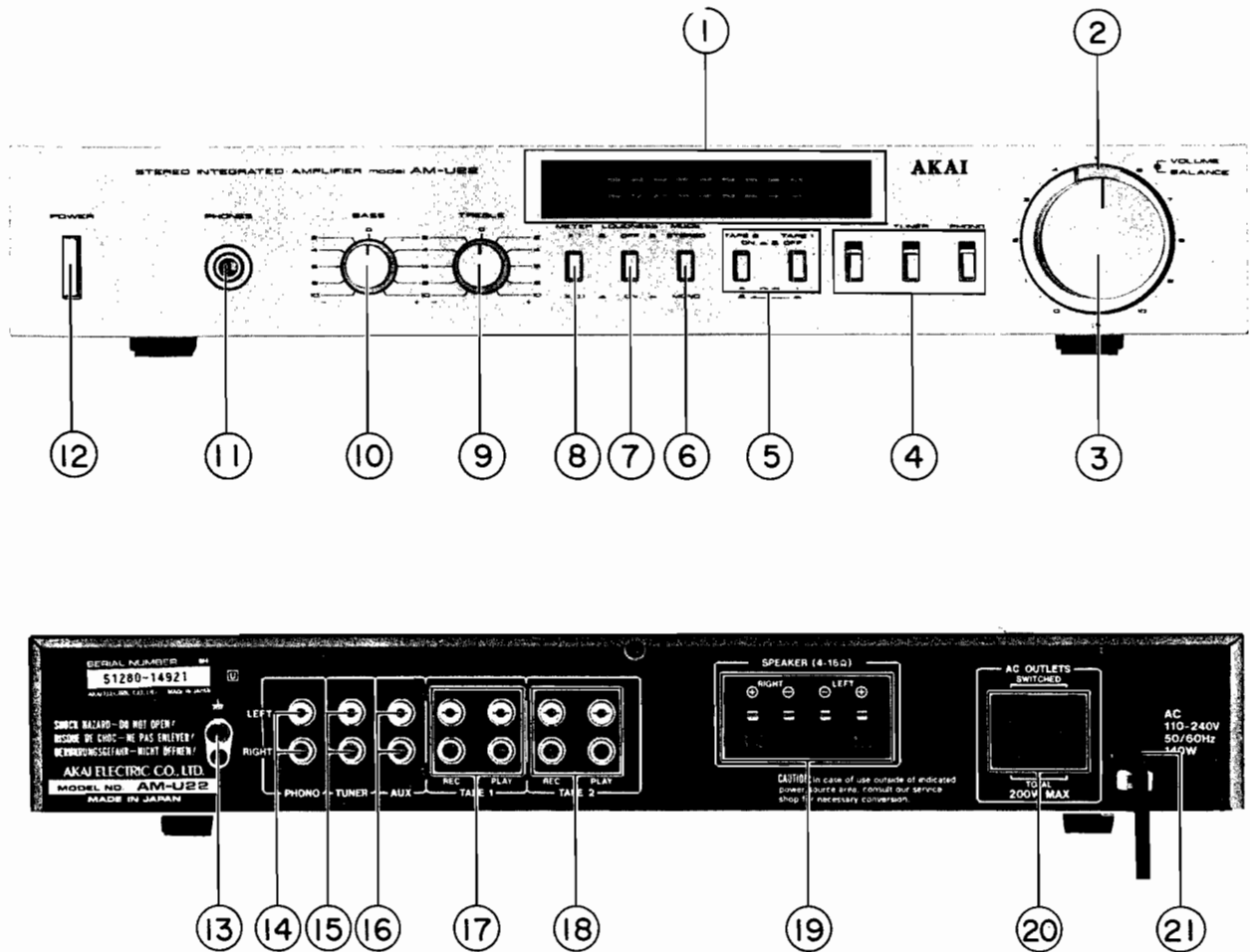

Fig. 2 Controls (AM-U22)

- |                                  |                                      |
|----------------------------------|--------------------------------------|
| 1. LED BAR METER                 | 12. POWER SWITCH                     |
| 2. STEREO BALANCE CONTROL        | 13. GROUND TERMINAL                  |
| 3. VOLUME CONTROL                | 14. PHONO JACKS                      |
| 4. INPUT SELECTOR AND INDICATORS | 15. TUNER JACKS                      |
| 5. TAPE MONITOR SWITCHES         | 16. AUX JACKS                        |
| 6. MODE SWITCH                   | 17. TAPE 1 SYSTEM REC/PLAY JACKS     |
| 7. LOUDNESS SWITCH               | 18. TAPE 2 SYSTEM REC/PLAY JACKS     |
| 8. METER SWITCH                  | 19. SPEAKER TERMINALS                |
| 9. TREBLE CONTROL                | 20. AC OUTLETS (U/T, AAL, CSA ONLY)  |
| 10. BASS CONTROL                 | 21. AC CORD (CEE, UK, SAA: AC INLET) |
| 11. HEADPHONE JACK (PHONES)      |                                      |



# IV. PRINCIPAL PARTS LOCATION

## 1. MODEL AM-U11

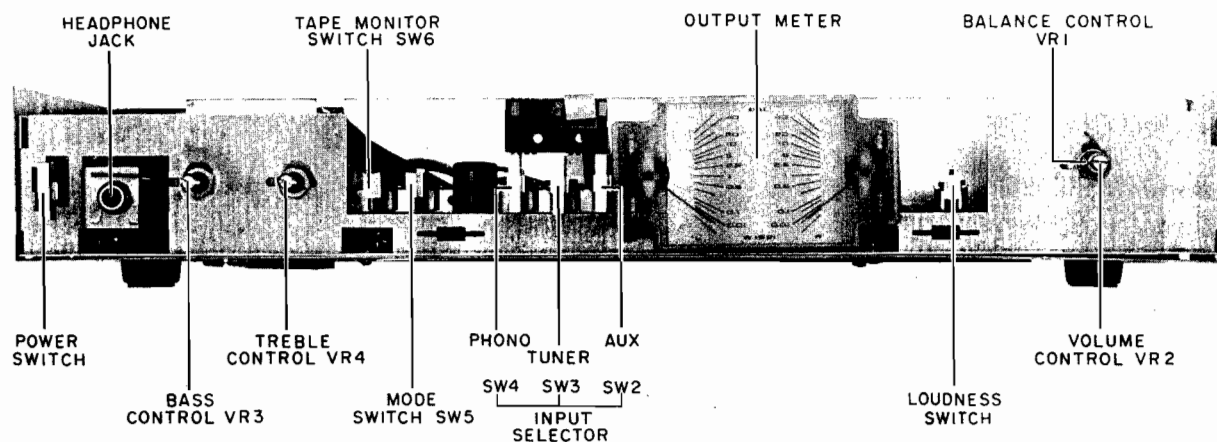

Fig. 3 Front View

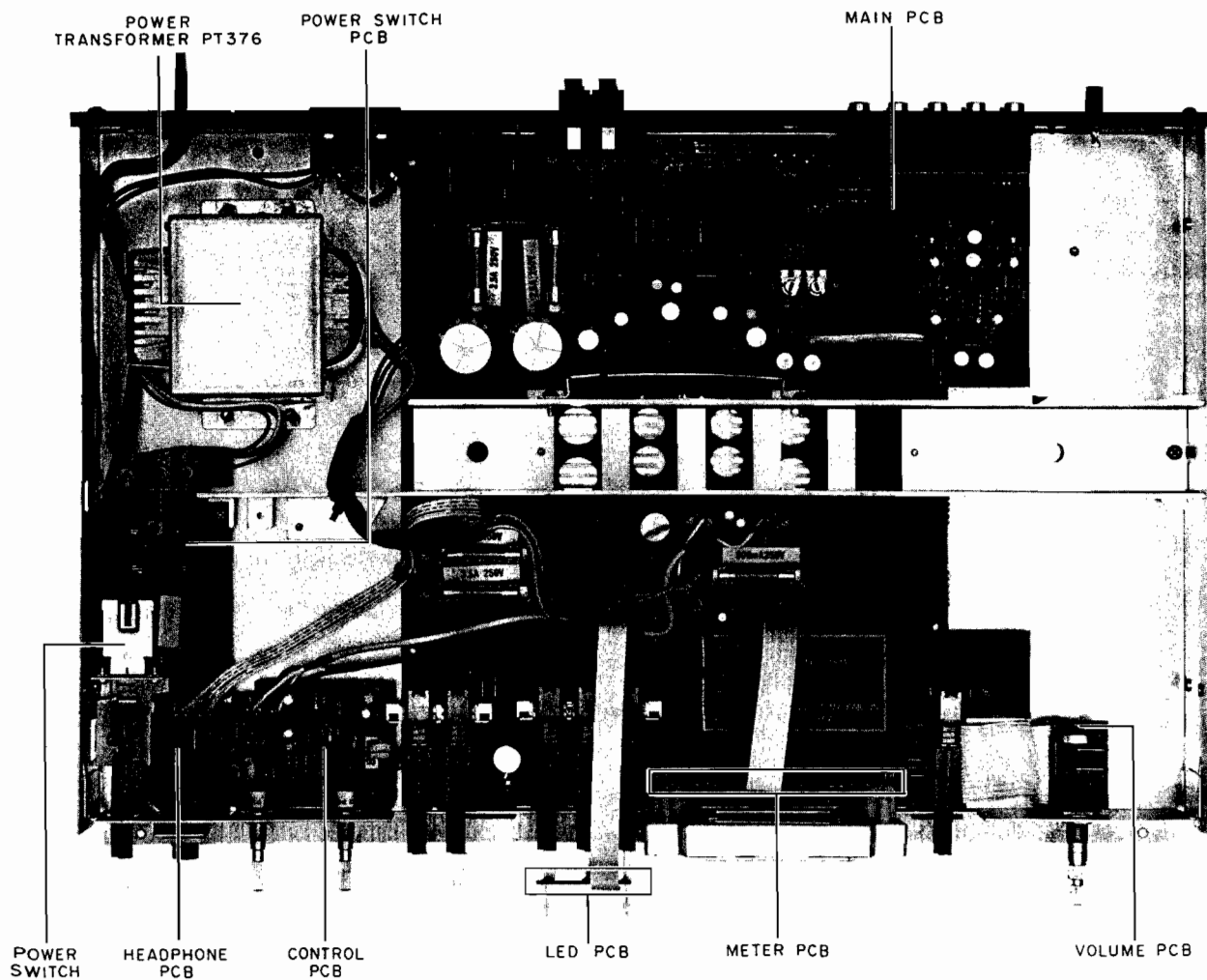

Fig. 4 Top View

2. MODEL AM-U22

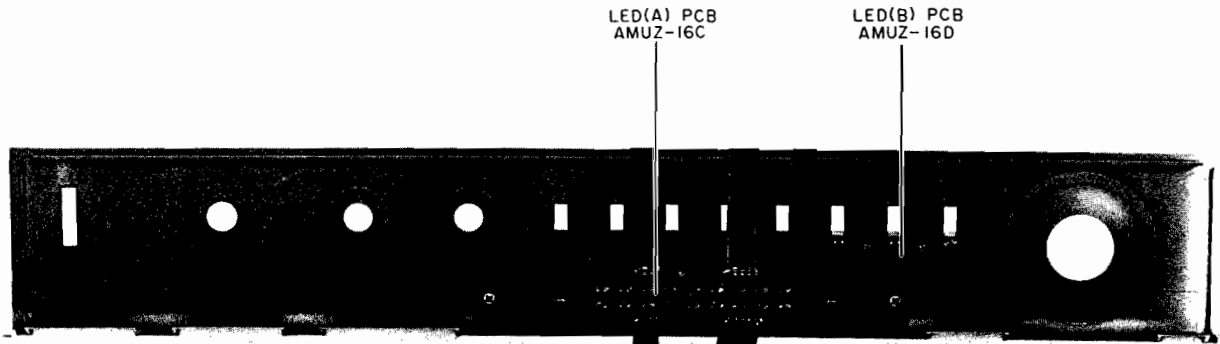

Fig. 5 Back View of Front Panel

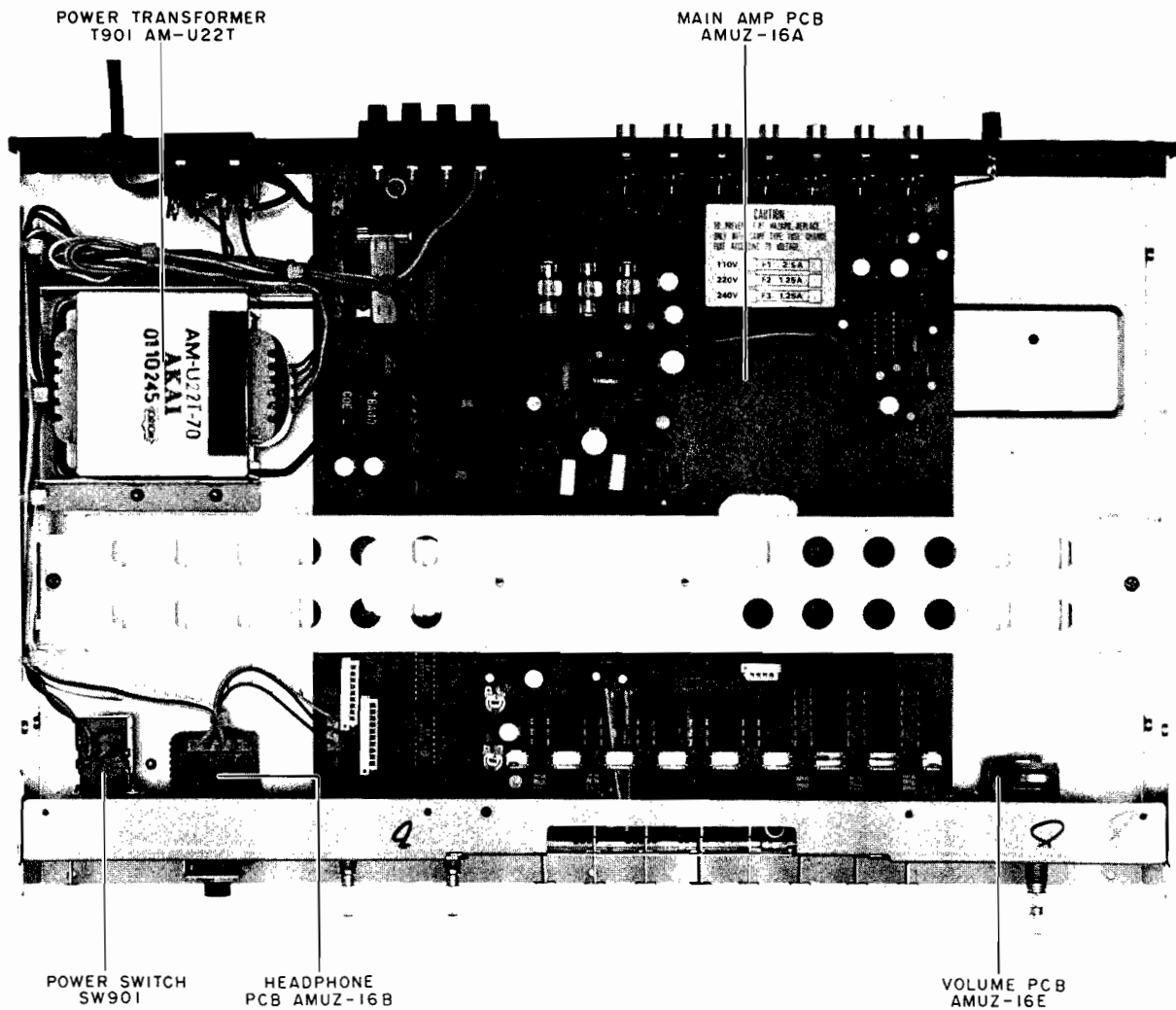

Fig. 6 Top View

# V. VOLTAGE CONVERSION

## 1. MODEL AM-U11

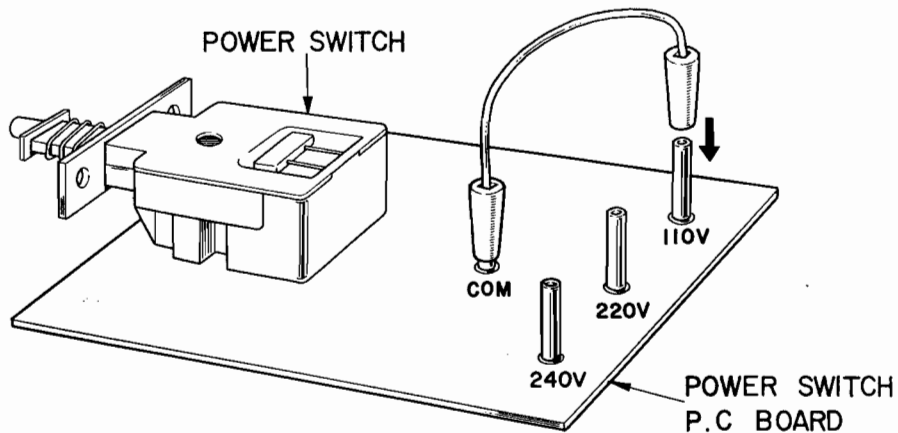

Fig. 7 Voltage Conversion (U/T Model Only)

This machine can be set to 110–120 V, 220 V or 240 V as required. Each machine is preset at the factory according to destination. However, if voltage change is necessary, this can be accomplished as follows:

1. Disconnect Power Cord.
2. Loosen holding screws and remove upper cover.
3. Remove Line Voltage wire and fit onto proper pins, explicitly following the printed instructions.

## 2. MODEL AM-U22

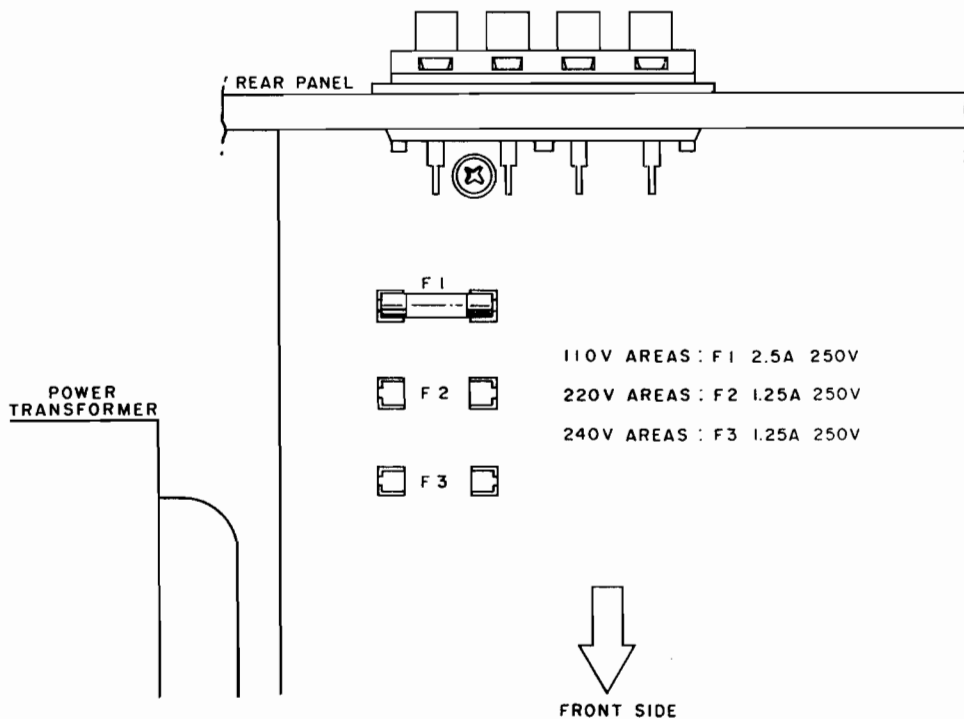

Fig. 8 Voltage Conversion (U/T Model Only)

Models for Canada, U.S.A., Europe, UK and Australia are not equipped with this facility.

Each machine is preset at the factory according to destination but some machines can be set to 110 V, 220 V, or 240 V as required.

If voltage change is necessary, this can be accomplished

as follows.

- 1) Disconnect AC Power Cord.
- 2) Loosen holding screws and remove upper cover.
- 3) Remove existing Line Voltage Fuse and insert required Line Voltage Fuse in proper fuse holder. Follow markings explicitly.

# VI. AMPLIFIER ADJUSTMENT

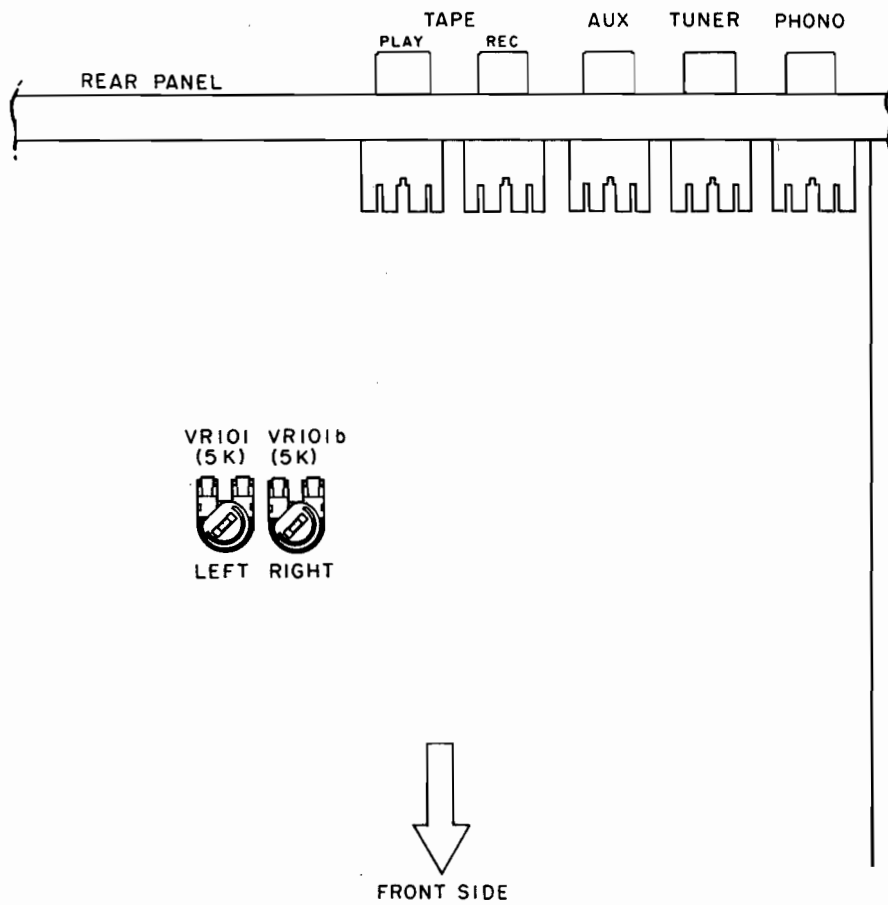

Fig. 9 Main P.C Board (AM-U11)

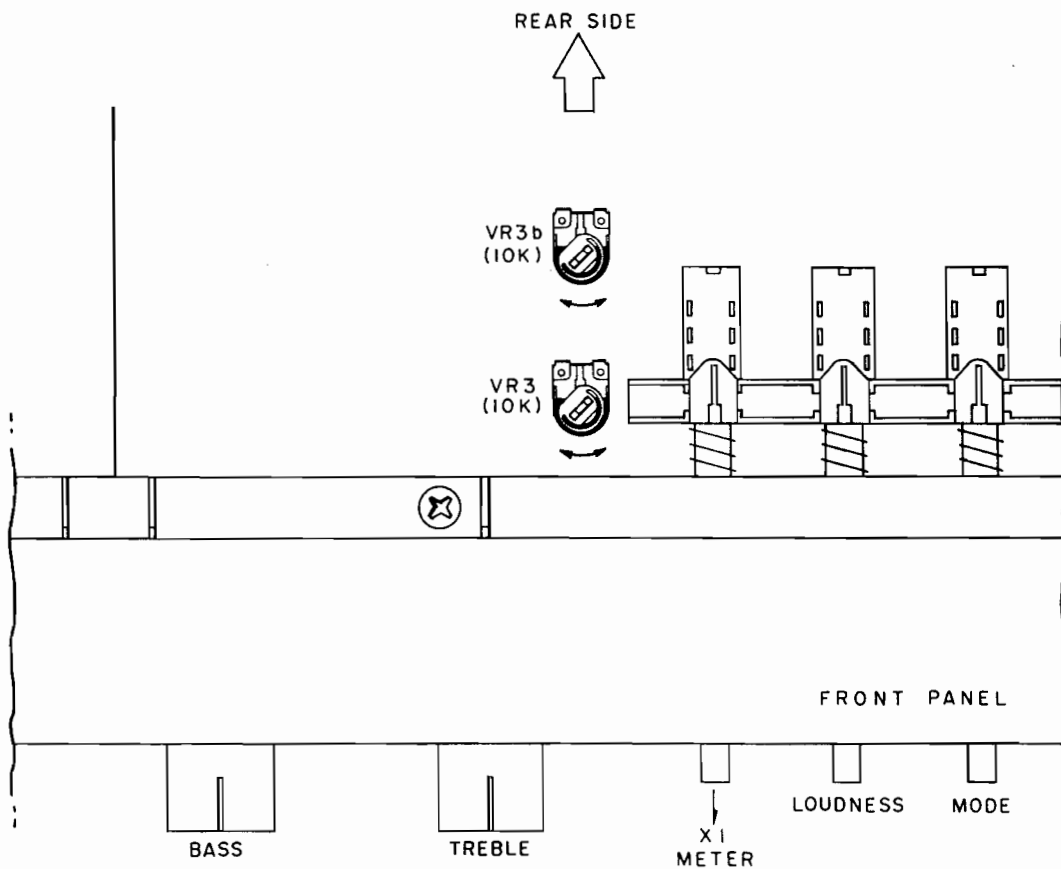

Fig. 10 Main Amp P.C Board AMUZ-16A (AM-U22)

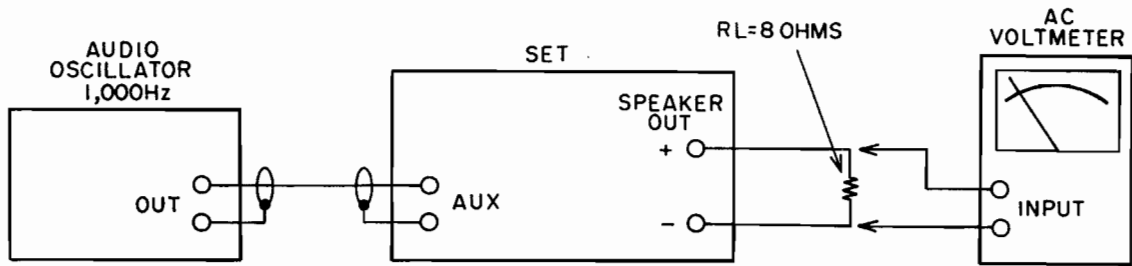

Fig. 11 Instrument Connections

## 1. POWER METER SENSITIVITY ADJUSTMENT

### 1) Model AM-U11 (Refer to Figs. 9, 11)

Connect the load resistors ( $RL=8$  ohms) to Speaker terminals. Then apply a 1 kHz signal to the AUX input terminals, adjusting the input level so as to obtain the rated output voltage level (12.65 V) at both ends of the load resistor. Adjust VR101 (left channel) and VR101b (right channel) until the Lever Meter reads 20W.

### 2) Model AM-U22 (Refer to Figs. 10, 11)

Set the Meter Range switch to "x1", and connect the load resistors ( $RL=8$  ohms) to Speaker terminals. Then apply a 1 kHz signal to the AUX input terminals, adjusting the input level so as to obtain the rated output voltage level (8.94 V) at both ends of the load resistor.

Adjust VR3 (left channel) and VR3b (right channel) on the Main Amp P.C Board so that the 7th LED (10 watts) in the Power Meter lights up.

## VII. CLASSIFICATION OF VARIOUS P.C BOARDS

---

### 1. P.C BOARD TITLES AND IDENTIFICATION NUMBERS

Model AM-U22

P.C Board Title	P.C Board Number
Main Amp P.C Board	AMUZ-16A
Headphone Jack P.C Board	AMUZ-16B
LED (A) P.C Board	AMUZ-16C
LED (B) P.C Board	AMUZ-16D
Volume P.C Board	AMUZ-16E

## 2. COMPOSITION OF VARIOUS P.C BOARDS

1) Model AM-U11 Main P.C Board, Headphone P.C Board, LED P.C Board, Meter P.C Board and Volume P.C Board

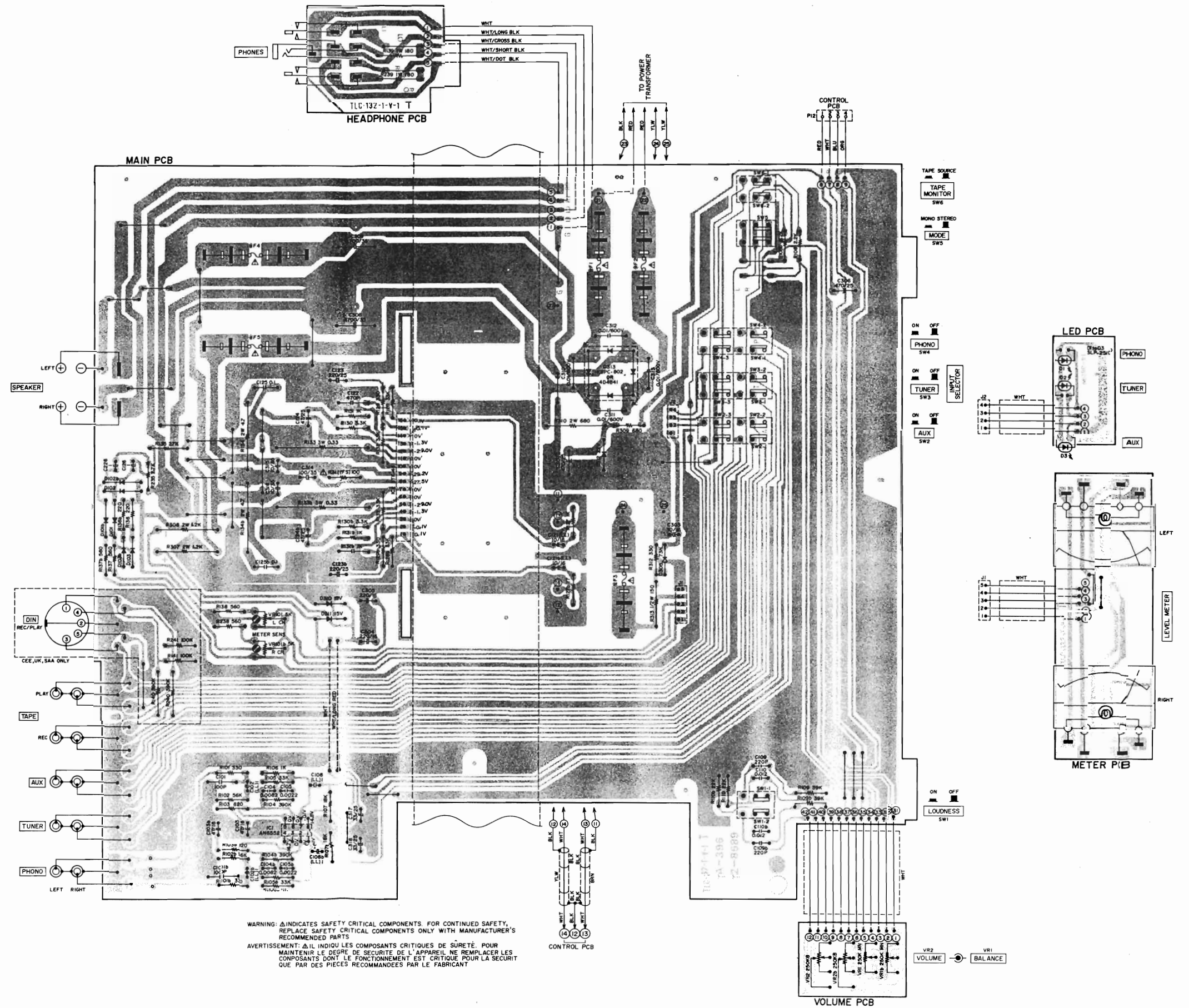

4) Model AM-U11 Power Switch P.C Board (AAL, CSA)

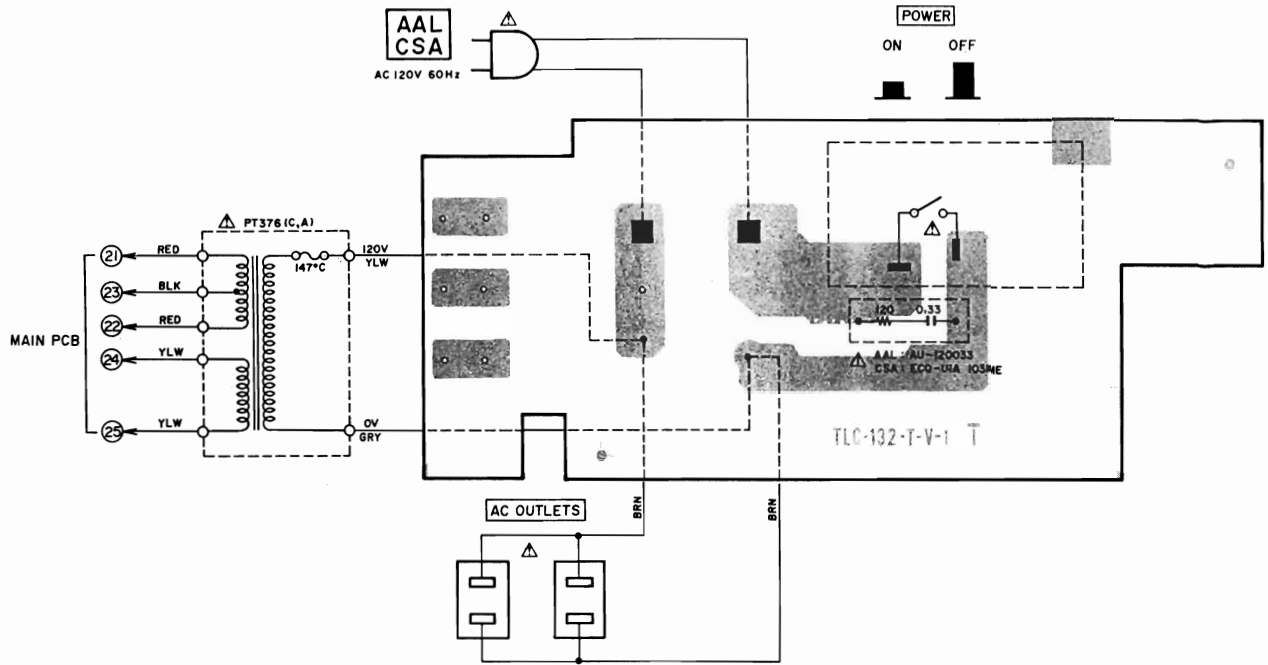

5) Model AM-U11; Power Switch P.C Board (CEE, UK, SAA)

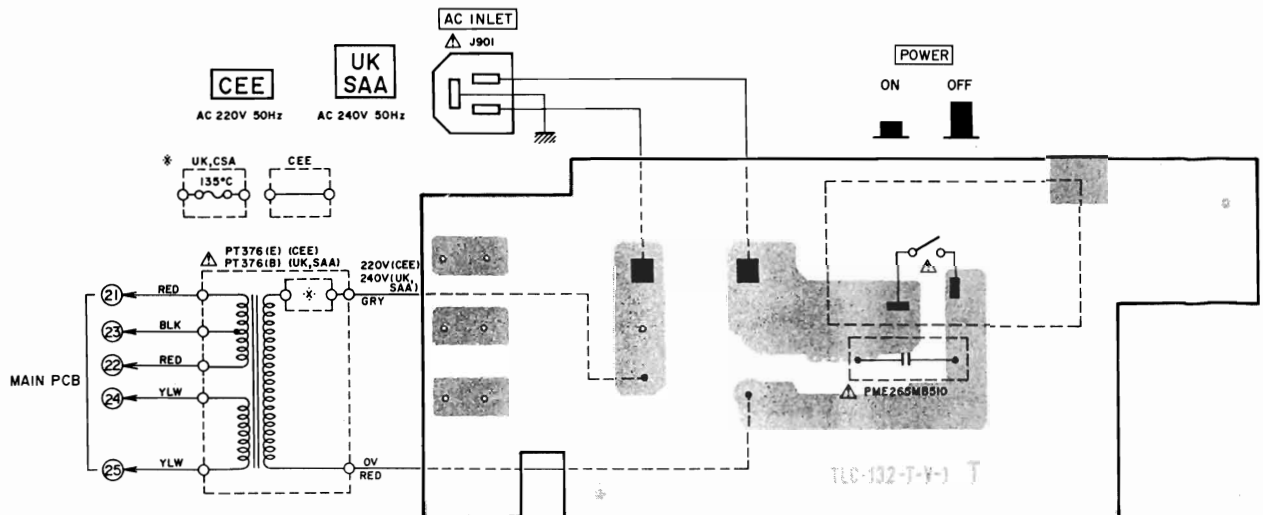

WARNING:  $\Delta$  INDICATES SAFETY CRITICAL COMPONENTS. FOR CONTINUED SAFETY, REPLACE SAFETY CRITICAL COMPONENTS ONLY WITH MANUFACTURER'S RECOMMENDED PARTS  
 AVERTISSEMENT:  $\Delta$  IL INDIQUE LES COMPOSANTS CRITIQUES DE SÛRETÉ. POUR MAINTENIR LE DEGRÉ DE SÛRETÉ DE L'APPAREIL NE REMPLACEZ PAS LES COMPOSANTS DONT LE FONCTIONNEMENT EST CRITIQUE POUR LA SÛRETÉ QUE PAR DES PIÈCES RECOMMANDÉES PAR LE FABRICANT



2) Model AM-U11 Control P.C Board

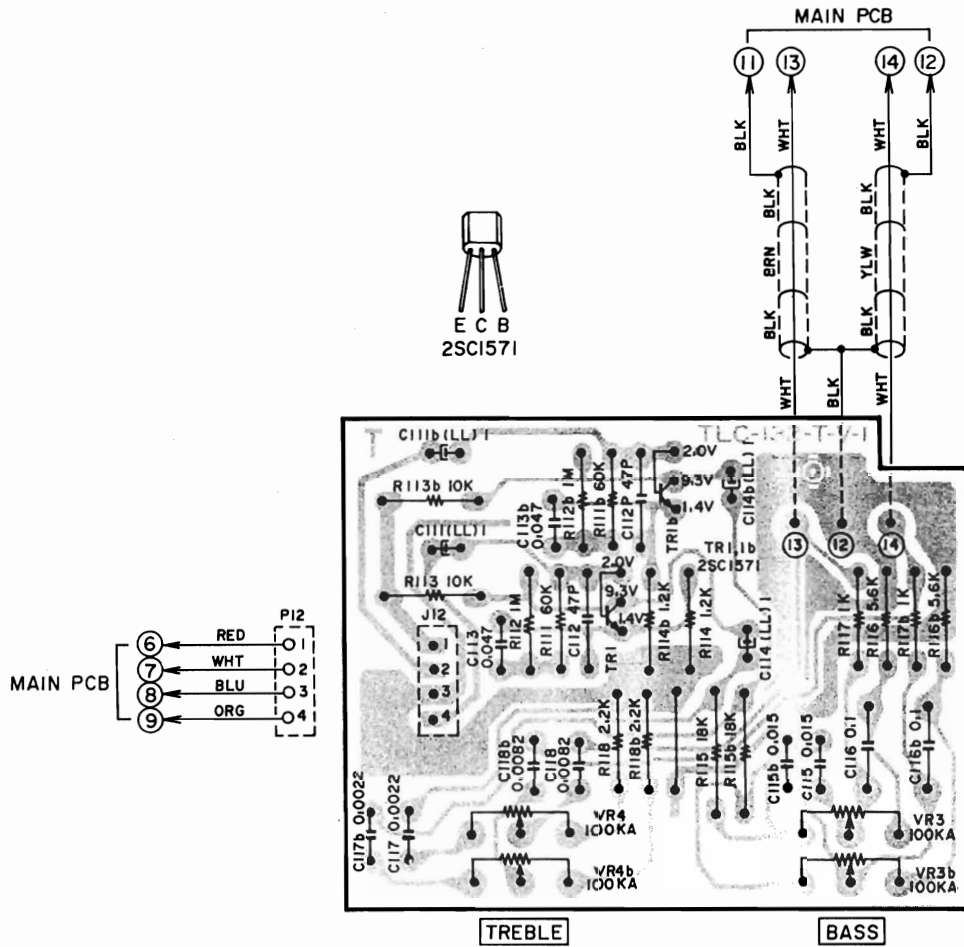

3) Model AM-U11 Power Switch P.C Board (U/T)

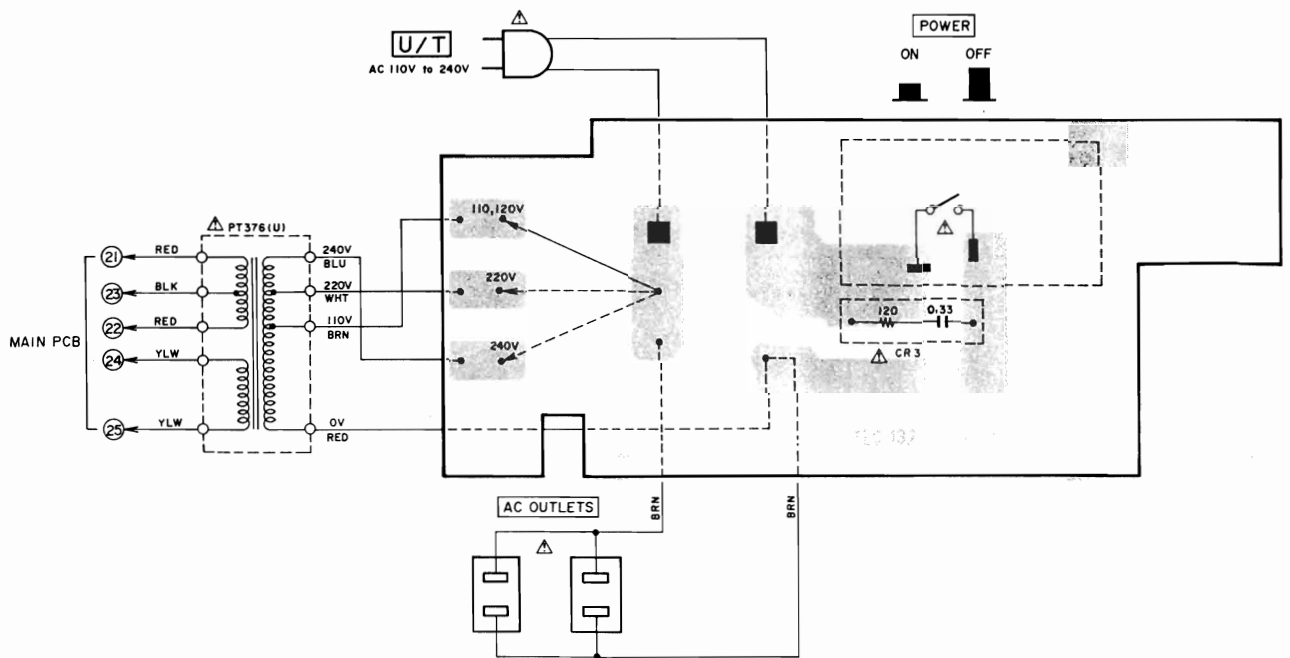

WARNING: Δ INDICATES SAFETY CRITICAL COMPONENTS. FOR CONTINUED SAFETY, REPLACE SAFETY CRITICAL COMPONENTS ONLY WITH MANUFACTURER'S RECOMMENDED PARTS.  
 AVERTISSEMENT: Δ IL INDIQUE LES COMPOSANTS CRITIQUES DE SÛRETÉ. POUR MAINTENIR LE DEGRÉ DE SÛRETÉ DE L'APPAREIL NE REMPLACER LES COMPOSANTS DONT LE FONCTIONNEMENT EST CRITIQUE POUR LA SÛRETÉ QUE PAR DES PIÈCES RECOMMANDÉES PAR LE FABRICANT.

6) Model AM-U22;

Main Amp P.C Board AMUZ-16A, Headphone Jack P.C Board AMUZ-16B, LED (A) P.C Board AMUZ-16C, LED (B) P.C Board AMUZ-16D and Volume P.C Board AMUZ-16E

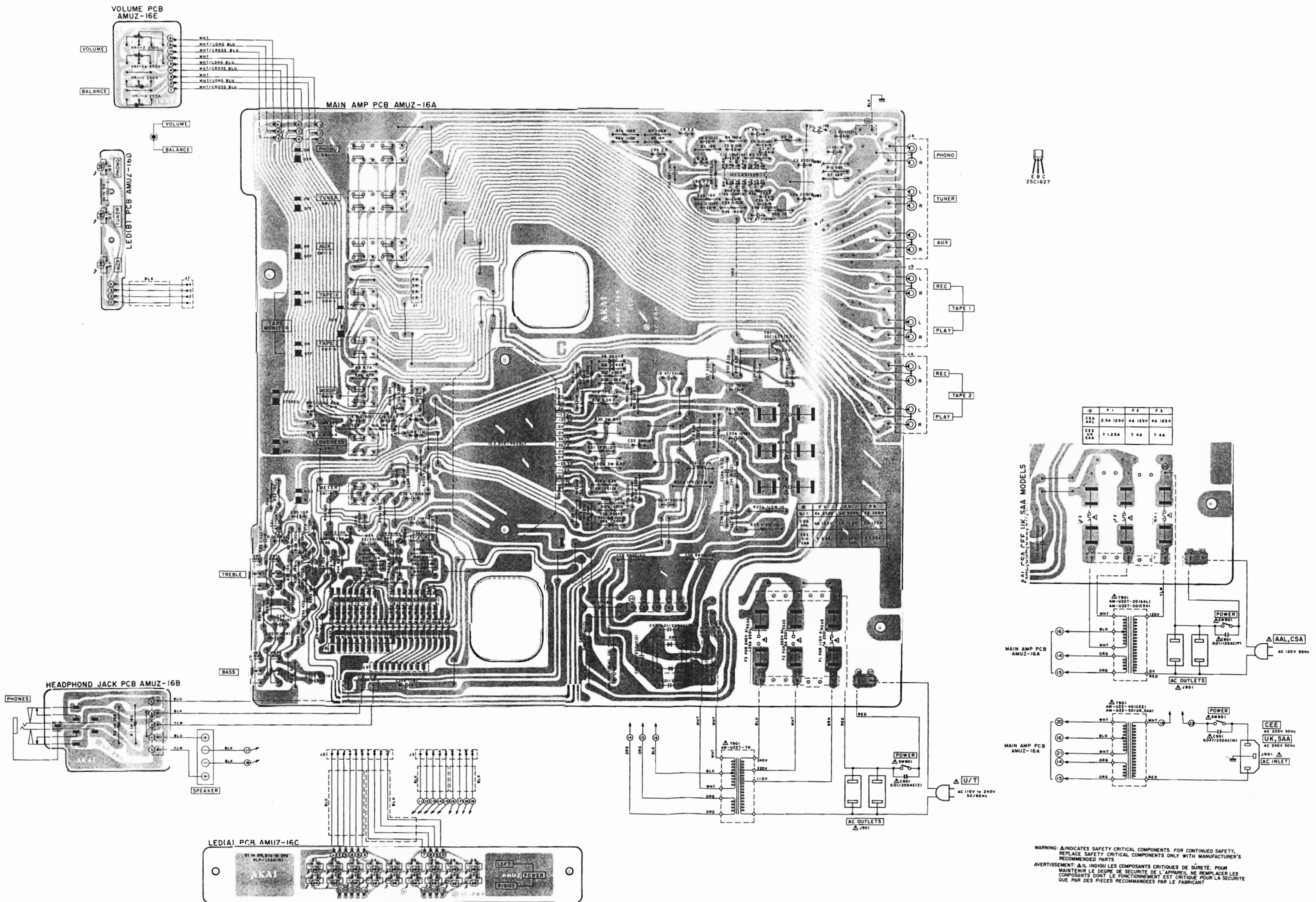

SECTION 3

# PARTS LIST

## TABLE OF CONTENTS

I. MODEL AT-K11	50
1. RECOMMENDED SPARE PARTS LIST	50
2. TUNER P.C BOARD (ATKZ-16A/47A/48A)	51
3. ASSEMBLY BLOCK	52
4. FINAL ASSEMBLY BLOCK	54
II. MODEL AT-K11L	55
1. TUNER P.C BOARD (ATKZ-48A) BLOCK	55
2. ANTENA SW P.C BOARD (ATK-2063) BLOCK	55
3. REAR PANEL BLOCK	55
4. FINAL ASSEMBLY BLOCK	55
III. MODEL AT-K22	56
1. RECOMMENDED SPARE PARTS LIST	56
2. TUNER P.C BOARD (ATKZ-16A/47A/48A) BLOCK	57
3. COUNTER P.C BOARD (ATKZ-17) BLOCK	57
4. ASSEMBLY BLOCK	58
5. FINAL ASSEMBLY BLOCK	60
IV. MODEL AT-K22L	61
1. TUNER P.C BOARD (ATKZ-48A) BLOCK	61
2. ANTENA SW P.C BOARD (ATK-2063) BLOCK	61
3. POWER SW BLOCK	61
4. REAR PANEL BLOCK	61
5. FINAL ASSEMBLY BLOCK	61
V. MODEL AM-U11	62
1. RECOMMENDED SPARE PARTS LIST	62
2. AMP P.C BOARD BLOCK	63
3. ASSEMBLY BLOCK	64
4. FINAL ASSEMBLY BLOCK	66
VI. MODEL AM-U22	67
1. RECOMMENDED SPARE PARTS LIST	67
2. MAIN AMP P.C (AMUZ-16A/23A/32A) BLOCK	68
3. ASSEMBLY BLOCK	69
4. FINAL ASSEMBLY BLOCK	70
INDEX	71

Resistor and Capacitor which is not listed in this parts list, please refer to COMMON LIST FOR SERVICE PARTS.



## HOW TO USE THIS PARTS LIST

1. This parts list is compiled by various individual blocks based on assembly process.
2. When ordering parts, please describe parts number, serial number, and model number in detail.
3. How to read list.

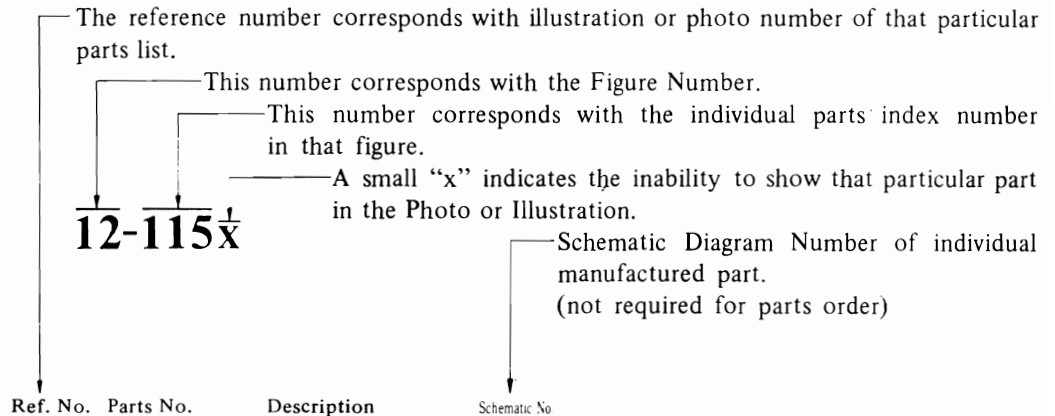

### FLYWHEEL BLOCK #13

12-115x	800425	Flywheel Block Assy. Comp.	RDG #13
12-116	244506	Flywheel Only	RD 233
12-117x	244754	Felt, Flywheel	RD 275
12-118	251324	Main Metal Case	RD 236
12-119	253080	Main Metal	RD 237

4. The symbol numbers shown on the P.C. Board list can be matched with the Composite Views of components of the Schematic Diagram or Service Manual.
5. The indications of Resistors and Capacitors in the photos of P.C. Board are being eliminated.
6. The shape of the parts and parts name, etc. can be confirmed by comparing them with the parts shown on the Electrical Parts Table of P.C. Board.
7. Both the kind of part and installation position can be determined by the Parts Number. To determine where a parts number is listed, utilize Parts Index at end of Parts List.  
It is necessary first of all to find the Parts Number. This can be accomplished by using the Reference Number listed at right of parts number in the Parts Index. (meaning of ref. no. outlined in Item 3 above).
8. Utilize separate "Price List for Parts" to determine unit price. The most simple method of finding parts Price is to utilize the reference number.

### CAUTION:

1. When placing an order for parts, be sure to list the parts no. model no., and description. There are instances in which if any of this information is omitted, parts cannot be shipped or the wrong parts will be delivered.
2. Please be careful not to make a mistake in the parts no. If the parts no. is in error, a part different from the one ordered may be delivered.
3. Because parts number and parts unit supply in the Preliminary Service Manual (Basic Parts List) may be partially changed, please use this parts list for all future reference.

**WARNING:**   △ INDICATES SAFETY CRITICAL COMPONENTS. FOR CONTINUED SAFETY, REPLACE SAFETY CRITICAL COMPONENTS ONLY WITH MANUFACTURER'S RECOMEMNDED PARTS.

**AVERTISSEMENT:**   △ IL INDIQU LES COMPOSANTS CRITIQUES DE SURETE. POUR MAINTENIR LE DEGRE DE SECURITE DE L'APPAREIL NE REMPLACER LES COMPOSANTS DONT LE FONCTIONNEMENT EST CRITIQUE POUR LA SECURITE QUE PAR DES PIECES RECOMMANDEES PAR LE FABRICANT.

## AC INLET SYSTEM

This model is equipped with an AC INLET SYSTEM. Please refer to the AC INLET SYSTEM CHART below for the specific type. By the AC INLET SYSTEM, AC (mains) cord can be connected to and disconnected from the model because the model is provided with socket exclusively for AC (mains) cord on its main body.

Please note, however, that certain models are not equipped with this system and has a built-in AC (mains) cord as before.

### AC INLET SYSTEM CHART

#### CLASS I

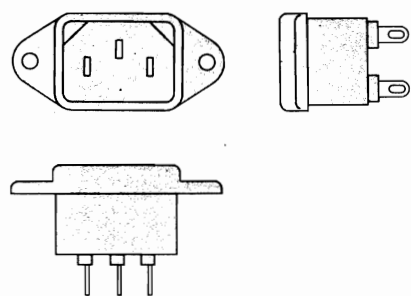

Picture 1  
AC INLET  
to be  
installed  
on machines

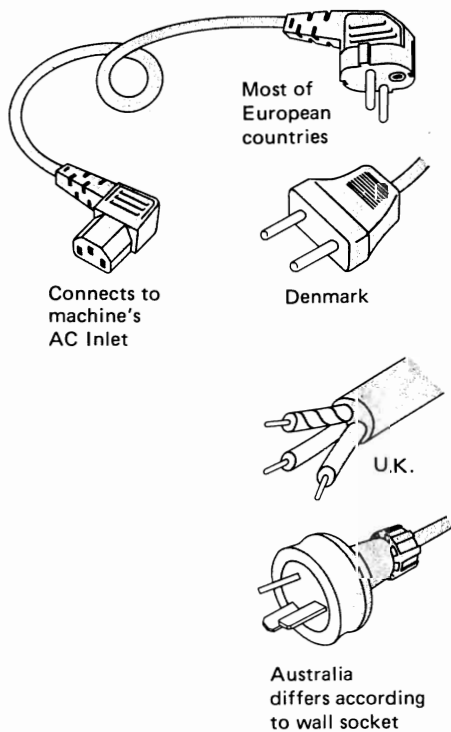

Picture 2  
AC (mains)  
cord

#### CLASS II

☐ This mark indicating double insulation will be attached to machine's rear panel

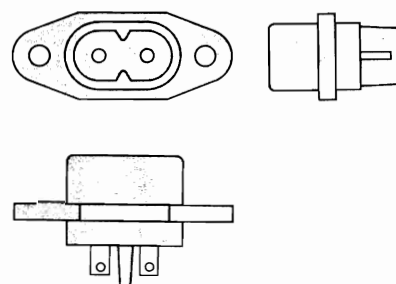

Connects to  
machine's  
AC Inlet

Most of the  
European  
countries



#### Parts List for AC (mains) Cord Set

	Standard	Description	Type of AC Inlet	Parts No.
Class I	CEE	Cord Set CEE (3 cores)	3P	EW302993
	UK	Cord Set UK (3 cores)	3P	EW302994
	SAA	Cord Set SAA (3 cores)	3P	EW302996
	U/T	Cord Set U/T (3 cores)	3P	EW302646
Class II	CEE	Cord Set CEE (2 cores)	2P	EW638144
	UK	Cord Set UK (2 cores)	2P	EW302995
	SAA	Cord Set SAA (2 cores)	2P	EW302991
	U/T	Cord Set U/T (2 cores)	2P	EW302899

# I. MODEL AT-K11

## 1. RECOMMENDED SPARE PARTS LIST

Because, if the parts listed below are on hand, almost any repair can be accomplished, we suggest that you stock these Recommended Spare Parts Items.

Parts No.	Description	Notes
BT201517	△ TRANS POWER AT-K11T-30	CSA, AAL
BT201518	△ TRANS POWER AT-K11T-40	CEE
BT201519	△ TRANS POWER AT-K11T-50	SAA
BT201520	△ TRANS POWER AT-K11T-70	U/T
EC616342	C S-FIX HCTY122D33 1.5-16	
ED322247	D LED SLP-151D RED	
ED322184	D LED SLP-152D RED	
ED322215	D LED SLP-251D GRN	
ED200469	D SILICON H DS448 FA1 F10	
ED200469	D SILICON H DS448 FA1 F10	
ED322238	D SILICON 1B4B41 100/1.0A	
ED323216	D ZENER H 05Z15 U	
EE322242	FRONT END FF126U12 87-108MC	
EF300590	△ FUSE EAWK T 250V 0.40A	CEE, SAA
EF308933	△ FUSE TSC A 250V 0.20A	U/T
EF309389	△ FUSE TSC A 250V 0.40A	U/T
EF308848	△ FUSE TSC 125V 0.40A	CSA, AAL
EI322248	IC LA1231N	
EI293185	IC LA1240	
EI650597	IC LA3350S	
EI315491	IC LB1405S	
EO328854	COIL DET2 Q228CEL-1098R	
EO328137	COIL FIX 2 NI-0036 2.2UH	
EO307186	COIL OSC 2 RWR-4308N 160UH	
ER293398	COIL IFT RMC-42246BCH 468KHZ	
ER307204	FILTER CE CFMA-008 0.468MHZ	
ER307201	FILTER CE SFE10.7MM-Z 10.7 MHZ	
ER328855	FILTER LC LP 12A1251 AKAI	
ES310839	△ SW PUSH SDG1P-E 01-1 E	U/T, CEE, SAA
ES665875	△ SW PUSH SDG1P-J 01-1 UC	CSA, AAL
ES201979	SW PUSH SUF12 2-02-02N	
ES201948	SW PUSH SUF22 2 THROW	
ET200506	TR 2SC2603 F	
ET316643	TR 2SC536K-NP F,G	
ET618873	TR 2SC930 E, F	
ET452531	TR 2SD313 E, F	
EV427858	R S-FIX H SR19R 3P 0.15W 472	
EV593368	R S-FIX H V10K8-4-2 3P 303	
EV499375	R S-FIX H V10K8-4-2 3P 501	

## 2. TUNER P.C BOARD (ATKZ-16A/47A/48A) BLOCK

REF. NO.	PARTS NO.	DESCRIPTION
2-1	BAA3008A020A	TUNER PC BLK AT-K11 (U)(U/T)
2-2	BAA3008A020B	TUNER PC BLK AT-K11 (C) (CSA,AAL)
2-3	BAA3008A020C	TUNER PC BLK AT-K11 (E) (CEE,SAA)
2-4	EE322242	FRONT END FF126U12 87-108MC
2-IC1	EI322248	IC LA1231N
2-IC2	EI650597	IC LA3350S
2-IC3	EI293185	IC LA1240
2-IC4	EI315491	IC LB1405S
2-TR1	ET618873	TR 2SC930 E,F
2-TR2 to 4	ET316643	TR 2SC536K-NP F,G
2-TR5,6	ET200506	TR 2SC2603 F
2-TR7 to 9	ET316643	TR 2SC536K-NP F,G
2-TR11	ET316643	TR 2SC536K-NP F,G
2-TR12	ET452531	△ TR 2SD313 E,F
2-TR13	ET316643	TR 2SC536K-NP F,G
2-D1 to 8	ED200469	D SILICON H DS448 FA1 F10
2-D9	ED323216	△ D ZENER H 05Z15 U
2-D10	ED322238	△ D SILICON 1B4B41 100/1.0A
2-D12	ED200469	D SILICON H DS448 FA1 F10
2-J1	EJ323227	PIN J T5727-A P 2P
2-SW1	ES201979	SW PUSH SUF12 2-02-02N
2-SW2	ES201948	SW PUSH SUF22 2 THROW
2-VR1,2	EV593368	R S-FIX H V10K8-4-2 3P 303
2-VR3	EV427858	R S-FIX H SR19R 3P 0.15W 472
2-VR4	EV499375	R S-FIX H V 10K8-4-2 3P 501
2-L1,2	EO328137	COIL FIX 2 NI-0036 2.2UH
2-T1	EO328854	COIL DET2 Q228CEL-1098R
2-T2	ER293398	COIL IFT RMC-42246 BCH 468.0KHZ
2-T3	ER307204	FILTER CE CFMA-008 0.468MHZ
2-T4	EO307186	COIL OSC 2 RWR-43208N 160UH
2-FL1,2	ER307201	FILTER CE SFE 10.7MM-Z 10.7MHZ
2-FL3,4	ER328855	FILTER LC LP 12A1251 AKAI
2-VC1,2	EC616342	C S-FIX H CTY122D33 1.5-16
2-R7,8	ER324337	△ R CB H SNP FS RDS 1/4W 560J
2-R13,14	ER324337	△ R CB H SNP FS RDS 1/4W 560J
2-R31,32	ER324337	△ R CB H SNP FS RDS 1/4W 560J
2-R56,57	ER324337	△ R CB H SNP FS RDS 1/4W 560J
2-R65,66	ER324337	△ R CB H SNP FS RDS 1/4W 560J
2-R73 to 75	ER324337	△ R CB H SNP FS RDS 1/4W 560J
2-R83	ER324185	△ R CB H SNP FS RDS 1/4W 221J
2-R96	ER669328	R SD 1/2W 225J
2-R97,98	ER324480	△ R CB H SNP FS RDS 1/4W 470J
2-C33	EC328862	C STY V F05 CQF09 152J 50DC
2-C57,58	EC200928	C CE V F05 SL 6R0D 50DC
2-C59	EC314996	C STY V SNP CQFS 391J 50DC
2-C76,77	EC328856	C STY V F05 CQF09 331K 50DC
2-TM1	EJ309941	TERMINAL W/SCREW UB-1059 P 4P



### 3. ASSEMBLY BLOCK

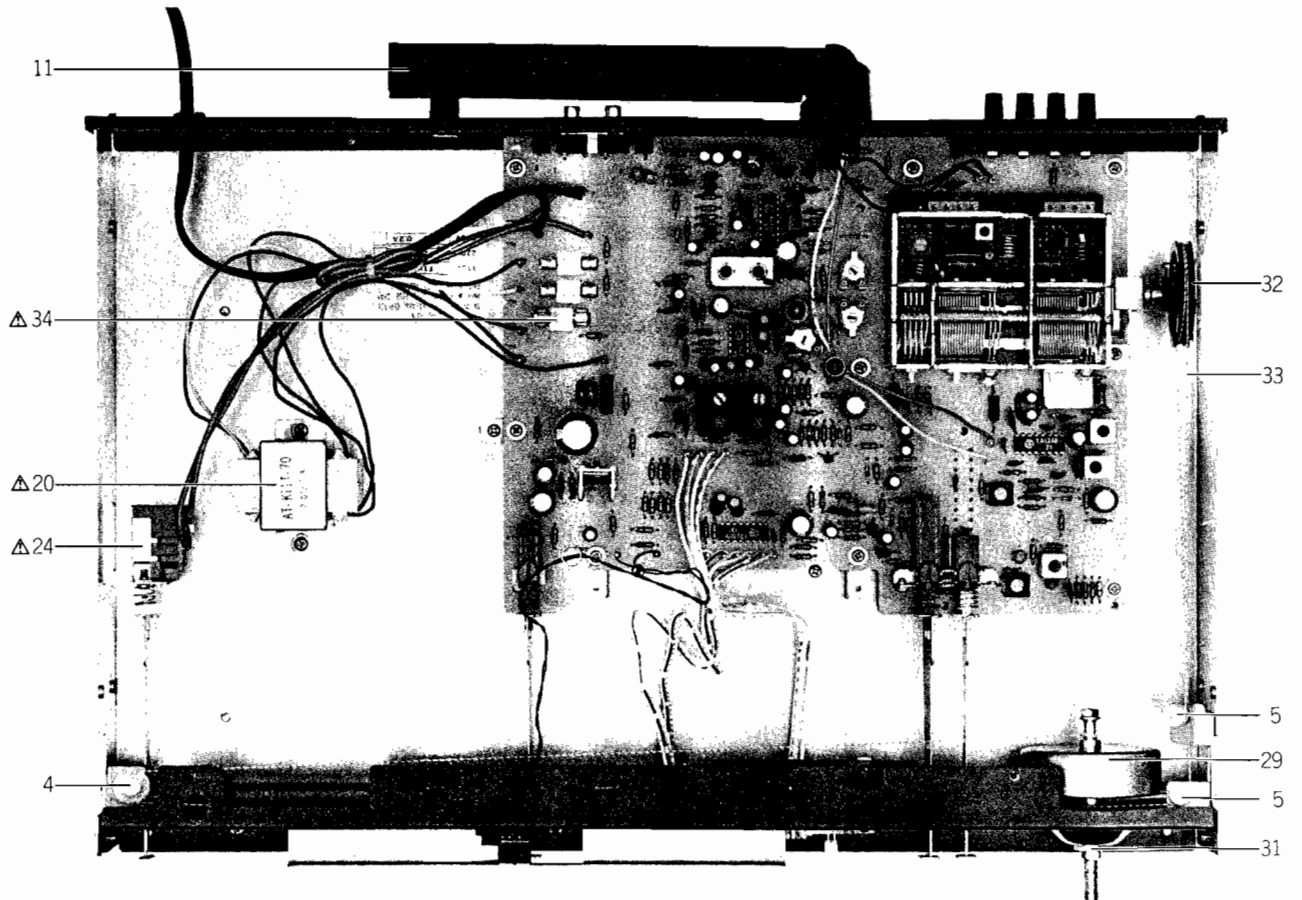
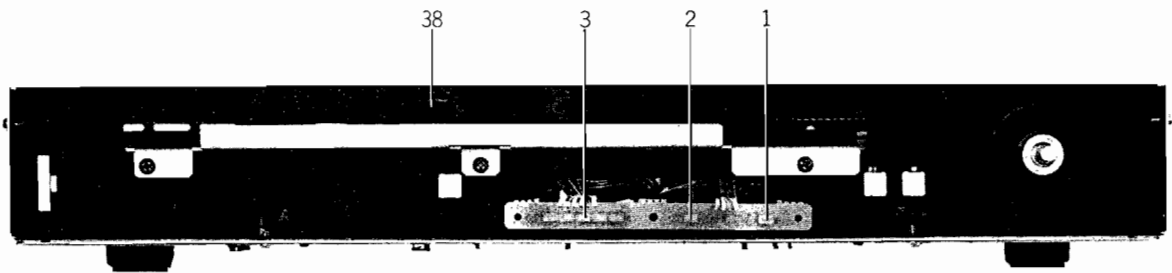
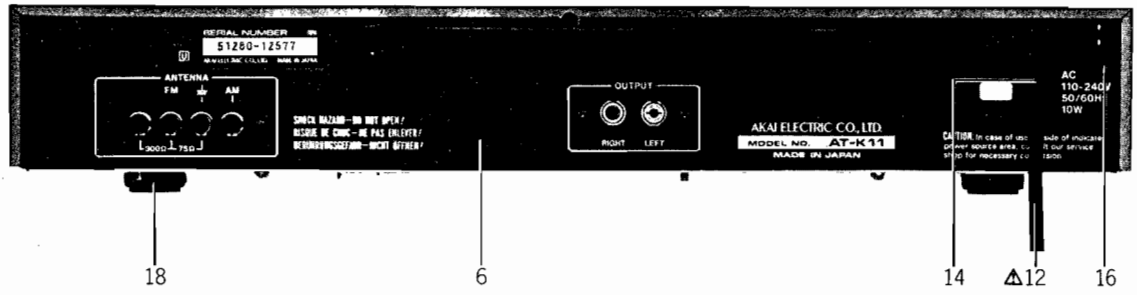

## ASSEMBLY BLOCK

REF. NO.	PARTS NO.	DESCRIPTION
<b>LED P.C BOARD BLOCK</b>		
3-1	ED322247	D LED SLP-151D RED
3-2	ED322215	D LED SLP-251D GRN
3-3	ED322184	D LED SLP-152D RDD
<b>ROLLER ANGLE (A) BLOCK</b>		
3-4	MZ307170	PULLEY
<b>ROLLER ANGLE (B) BLOCK</b>		
3-5	MR308836	PULLEY
<b>REAR PANEL BLOCK</b>		
3-6	SP329253H	REAR PANEL AT-K11 (U)
3-7x	SP329253J	REAR PANEL AT-K11 (C)
3-8x	SP329253K	REAR PANEL AT-K11 (A)
3-9x	SP329253L	REAR PANEL AT-K11 (E)
3-10x	SP329253M	REAR PANEL AT-K11 (S)
3-11	EE200184	ANT BAR AT-K200 MW
3-12	EW306428	△ AC CORD 2 CORES KP-205A, VFF UCJ (U/T)
3-13x	EW305691	△ AC CORD 2 CORES KP-8, SPT-1 UC (CSA,AAL)
3-14	EZ631945	STRAIN RELIEF SR-4N-4 (U/T CSA,AAL)
3-15x	EJ301513	△ SOCKET INLET S-I6453 E 2P (CEE, SAA)
<b>ASSEMBLY BLOCK</b>		
3-16	ZS319460	T2BR 30x06 STL BZN PROJEC- TION
3-17x	ZS325495	T2BR 30x06 STL CMT
3-18	SA311742	ROUND FOOT
3-19x	ZS463094	T2BID40x08STL CMT
3-20	BT201520	△ TRANS POWER AT-K11T-70 (U/T)
3-21x	BT201517	△ TRANS POWER AT-K11T-30 (CSA, AAL)
3-22x	BT201518	△ TRANS POWER AT-K11T-40 (CEE)
3-23x	BT201519	△ TRANS POWER AT-K11T-50 (SAA)
3-24	ES310839	△ SW PUSH SDG1P-E 01-1 E (U/T, CEE,SAA)
3-25x	EX665875	△ SW PUSH SDG1P-J 01-1 UC (CSA,AAL)
3-26x	EC320548	△ C CE V F 103Z 250AC (U/T)
3-27x	EC314688	△ C CE V FZ 103P 125AC (CSA, AAL)
3-28x	EC330307	△ C MMY V ECQUF 472M 250AC (CEE, SAA)
3-29	TA328846	TUNING WHEEL
3-30x	ZW436026	PW92x150x050STL CMT
3-31	ZW270191	E JACK NUT SPCC CMT
3-32	TA322250	DIAL WHEEL ASSY
3-33	TA201961	DIAL STRING TK-1064 (BLACK) D0.5
3-34	EF309389	△ FUSE TSC A 250V 0.40A (U/T)
3-35x	EF308933	△ FUSE TSC A 250V 0.20A (U/T)
3-36x	EF308848	△ FUSE TSC 125V 0.40A (CSA, AAL)
3-37x	EF300590	△ FUSE EAWK T 250V 0.40A (CEE, SAA)
3-38	TAB201457	POINTER PART BQ606-32800B
3-39x	EW315767	△ AC CORD 2 CORES KP-419C/ KS-15 E (CEE)
3-40	EW322401	△ AC CORD 2 CORES KP-560/ S-15 S (SAA)

#### 4. FINAL ASSEMBLY BLOCK

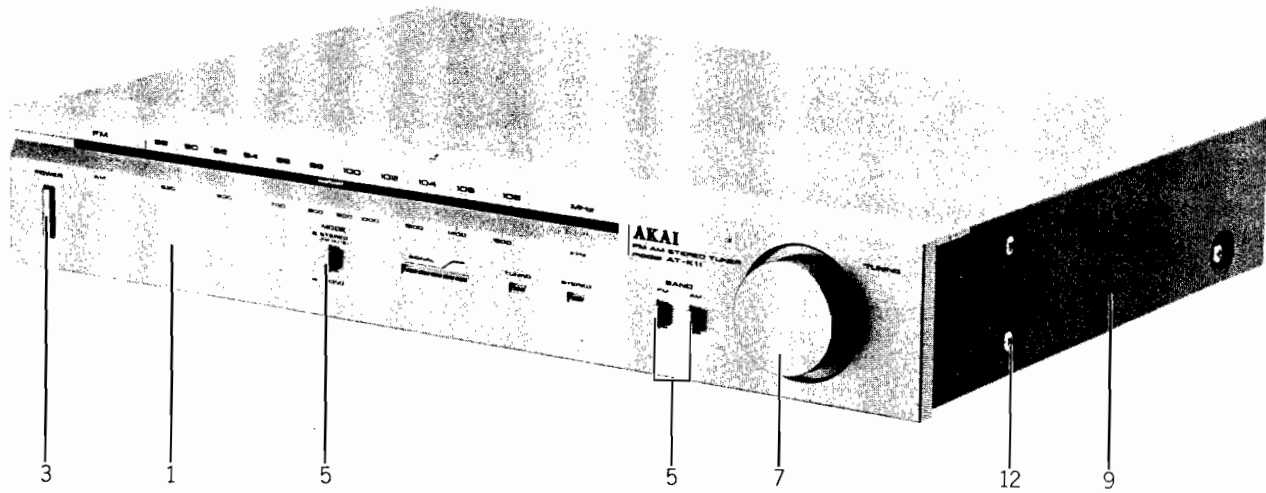

#### FINAL ASSEMBLY BLOCK

REF. NO.	PARTS NO.	DESCRIPTION
4-1	SP201020A	FRONT PANEL AT-K11
4-2x	SP201020B	FRONT PANEL AT-K11-BL
4-3	SB316498	BUTTON (B)
4-4x	SB316499	BUTTON (B-BL)
4-5	SB329581A	BUTTON
4-6x	SB329581B	BUTTON (BL)
4-7	SK322207	TUNING KNOB (A)
4-8x	SK322208	TUNING KNOB (A-BL)
4-9	BC322209	UPPER COVER (A) (U/T,CSA,CEE,SAA)
4-10x	BC322210	UPPER COVER (A-BL)
4-11x	BC322212	UPPER COVER (B)
4-12	ZS322570	ST BID40x08STL NI3
4-13x	ZS322580	ST BID40x08STL BNI (AAL,BL)
4-14x	ZS319460	T2BR30x06STL BZN PROJECTION
4-15x	ZW305013	RV POP32

## II. MODEL AT-K11L

\*The composite parts of Model AT-K11L, except for those which have been changed as per the List below, are identical to those of Model AT-K11 Therefore, when ordering parts for this tape deck, please utilize Model AT-K11 Parts List.

### 1. TUNER P.C BOARD (ATKZ-48A) BLOCK

REF. NO.	PARTS NO.	DESCRIPTION
1-1	BAA3008C020A	TUNER PC BLK AT-K11L
1-SW3	ES200829	SW PUSH SUF22 2 THROW
1-T5	EO201252	COIL OSC2 RNR-44498N 600 UH
1-C67	EC200928	C CE V F05 SL 6R0D 50DC
1-C68	EC201253	C STY V F05 CQF09 161J 50DC
1-C70	EC200930	C CE V F05 SL 4R0D 50DC
1-C92	EC200930	C CE V F05 SL 4R0C 50DC

### 2. ANTENA SW P.C BOARD (ATK-2063) BLOCK

REF. NO.	PARTS NO.	DESCRIPTION
2-SW1	ES319168	SW PUSH SUF12 2-04-02N
2-L1	EO485278	COIL FIX1 FL05H 220UH K
2-T1	EO324453	COIL VARI2 RUR-44313N
2-VC1	EC616342	C S-FIX H CTY 122D33 1.5-16
2-VC2	EC616342	C S-FIX H CTY 122D33 1.5-16

### 3. REAR PANEL BLOCK

REF. NO.	PARTS NO.	DESCRIPTION
3-1	SP329253P	REAR PANEL AT-K11L (E)
3-2	SP329253Q	REAR PANEL AT-K11L (B,S)
3-3	EE200810	ANT BAR AT-K22L LW/MW
3-4	EJ301513	△ SOCKET INLET S-16453 E 2P (CEE,UK)
3-5	SK607127	PUSH KNOB (A)

### 4. FINAL ASSEMBLY BLOCK

REF. NO.	PARTS NO.	DESCRIPTION
4-1	BT330409	△ TRANS POWER AT-K11LT-40 (CEE)
4-2	BT330410	△ TRANS POWER AT-K11LT-50 (UK)
4-3	ES310839	△ SW PUSH SDG1P-E 01-1 E (CEE,UK)
4-4	EC330307	△ C MMY V ECQUF 472M 250AC (CEE,UK)
4-5	EF300590	△ FUSE EAWK 250V 0.40A (CEE,UK)
4-6	SP201020C	FRONT PANEL AT-K11L
4-7	SP201020D	FRONT PANEL AT-K11L-BL
4-8	EW315767	△ AC CORD 2 CORES KP-419/ KS-15 E (CEE)
4-9	EW302995	△ AC CORD 2 CORES VN-0112 B (UK)

### III. MODEL AT-K22

#### 1. RECOMMENDED SPARE PARTS LIST

Because, if the parts listed below are on hand, almost any repair can be accomplished, we suggest that you stock these Recommended Spare Parts Items.

Parts No.	Description	Notes
BT328843	△ TRANS POWER AT-K200T-30	CSA, AAL
BT238844	△ TRANS POWER AT-K200T-40	CEE
BT328845	△ TRANS POWER AT-K200T-50	SAA
BT328842	△ TRANS POWER AT-K200T-70	U/T
EC616342	C S-FIX H CTY122D33 1.5-16	
ED322247	D LED SLP-151D RED	
ED322184	D LED SLP-152D RED	
ED322215	D LED SLP-251D GRN	
ED200469	D SILICON H DS448 FA1 F10	
ED200469	D SILICON H DS 448 FA1 F10	
ED322238	D SILICON 1B4B41 100/1.0A	
ED224526	D SILICON 10D1 100/1.0A	
ED309959	D ZENER H HZ5 C3	
ED323216	D ZENER H 05Z15 U	
ED325080	D ZENER H 05Z9.1 L	
EE325737	FRONT END FF136U12 87-108MC	
EF300590	△ FUSE EAWK T 250V 0.40A	CEE, SAA
EF308933	△ FUSE TSC A 250V 0.20A	U/T
EF309389	△ FUSE TSC A 250V 0.40A	U/T
EF308848	△ FUSE TSC 125V 0.40A	CSA, AAL
EI322248	IC LA1231N	
EI293185	IC LA1240	
EI650597	IC LA3350S	
EI315491	IC LB1405S	
EI328850	IC LC7259	
EI328849	IC M54459L	
EI323231	OSC X'TAL 4MHZ	
EM328848	IND LE SL-1713WCHARACTER	
EO328854	COIL DET2 Q228CEL-1098R	
EO328137	COIL FIX 2 NI-0036 2.2UH	
EO328137	COIL FIX 2 NI-0036 2.2UH	
EO307186	COIL OSC 2 RWR-4308N 160UH	
ER293398	COIL IFT RMC-42246BCH 468KHZ	
ER307204	FILTER CE CFMA-008 0.468MHZ	
ER307201	FILTER CE SFE10.7MM-Z 10.7 MHZ	
ER328855	FILTER LC LP 12A1251 AKAI	
ES310839	△ SW PUSH SDG1P-E 01-1 E	U/T, CEE, SAA
ES665875	△ SW PUSH SDG1P-J 01-1 UC	CSA, AAL
ES201979	SW PUSH SUF12 2-02-02N	
ES201948	SW PUSH FUF22 2 THROW	
ET323232	TR FET 2SK9Y	
ET200506	TR 2SC2603 F	
ET316171	TR 2SC536K-NP E, F	
ET316643	TR 2SC536K-NP F, G	
ET618873	TR 2SC930 E, F	
ET618873	TR 2SC930 E, F	
ET452531	TR 2SD313 E, F	
EV427858	R S-FIX H SR19R 3P 0.15W 472	
EV604438	R S-FIX H V 10K8-4-2 3P 103	
EV593368	R S-FIX H V10K8-4-2 3P 303	
EV499375	R S-FIX H V10K8-4-2 3P 501	

## 2. TUNER P.C BOARD (ATKZ-16A/47A/48A) BLOCK

REF. NO.	PARTS NO.	DESCRIPTION
2-1	BAA3009A050A	TUNER PC BLK AT-K22 (U)(U/T)
2-2	BAA3009A050B	TUNER PC BLK AT-K22 (C) (CSA,AAL)
2-3	BAA3009A050C	TUNER PC BLK AT-K22 (E) (CEE,SAA)
2-4	EE325737	FRONT END FF136U12 87-108MC
2-IC1	EI322248	IC LA1231N
2-IC2	EI650597	IC LA3350S
2-IC3	EI293185	IC LA1240
2-IC4	EI315491	IC LB1405S
2-TR1	ET618873	TR 2SC930 E,F
2-TR2 to 4	ET316643	TR 2SC536K-NP F,G
2-TR5,6	ET200506	TR 2SC2603 F
2-TR7 to 9	ET316643	TR 2SC536K-NP F,G
2-TR10	ET-323232	TR FET 2SK19 Y
2-TR11	ET316643	TR 2SC536K-NP F,G
2-TR12	ET452531	△ TR 2SD313 E,F
2-TR13	ET316643	TR 2SC536K-NP F,G
2-D1 to 8	ED200469	D SILICON H DS448 FA1 F10
2-D9	ED323216	△ D ZENER H 05Z15 U
2-D10	ED322238	△ D SILICON 1B4B41 100/1.0A
2-D11	ED224526	△ D SILICON 10D1 100/1.0A
2-D12	ED200469	D SILICON H DS448 FA1 F10
2-J1	EJ323227	PIN J T5727-A P 2P
2-SW1	ES201979	SW PUSH SUF12 2-02-02N
2-SW2	ES201948	SW PUSH SUF22 2 THROW
2-VR1,2	EV593368	R S-FIX H V10K8-4-2 3P 303
2-VR3	EV427858	R S-FIX H SR19R 3P 0.15W 472
2-VR4	EV499375	R S-FIX H V 10K8-4-2 3P 501
2-L1,2	EO328137	COIL FIX 2 NI-0036 2.2UH
2-T1	EO328854	COIL DET2 Q228CEL-1098R
2-T2	ER293398	COIL IFT RMC-42246 BCH 468.0KHZ
2-T3	ER307204	FILTER CE CFMA-008 0.468MHZ
2-T4	EO307186	COIL OSC 2 RWR-43208N 160UH
2-FL1,2	ER307201	FILTER CE SFE 10.7MM-Z 10.7MHZ
2-FL3,4	ER328855	FILTER LC LP 12A1251 AKAI
2-VC1,2	EC616342	C S-FIX H CTY122D33 1.5-16
2-R7,8	ER324337	△ R CB H SNP FS RDS 1/4W 560J
2-R13,14	ER324337	△ R CB H SNP FS RDS 1/4W 560J
2-R31,32	ER324337	△ R CB H SNP FS RDS 1/4W 560J
2-R56,57	ER324337	△ R CB H SNP FS RDS 1/4W 560J
2-R65,66	ER324337	△ R CB H SNP FS RDS 1/4W 560J
2-R73 to 75	ER324337	△ R CB H SNP FS RDS 1/4W 560J
2-R83	ER324185	△ R CB H SNP FS RDS 1/4W 221J
2-R96	ER669328	R SD 1/2W 225J
2-R97,98	ER324480	△ R CB H SNP FS RDS 1/4W 470J
2-C33	EC328862	C STY V F05 CQF09 152J 50DC
2-C57,58	EC200928	C CE V F05 SL 6R0D 50DC
2-C59	EC314996	C STY V SNP CQFS 391J 50DC
2-C76,77	EC328856	C STY V F05 CQF09 331K 50DC
2-TM1	EJ309941	TERMINAL W/SCREW UB-1059 P

4P

## 3. COUNTER P.C BOARD (ATKZ-17) BLOCK

REF. NO.	PARTS NO.	DESCRIPTION
3-1	BA-A3009A070A	COUNTER PC BLK AT-K22
3-IC1	EI328849	IC M54459L
3-IC2	EI328850	IC LC7259
3-TR1	ET618873	TR 2SC930 E,F
3-TR2	ET316171	TR 2SC536K-NP E,F
3-D1,2	ED200469	D SILICON H DS448 FA1 F10
3-D3	ED325080	D ZENER H 05Z9.1 L
3-D4	ED309959	D ZENER H HZ5 C3
3-VR1,2	EV604438	R S- FIX H V10K8-4-2 3P 103
3-L1 to 3	EO328137	COIL FIX 2 NI-0036 2.2UH
3-IND1	EM328848	IND LE SL-1713W CHARACTER
3-X1	EI323231	OSC X'TAL 4MHZ
3-R35	ER324185	R CB H SNP FS RDS 1/4W 221J
3-R38	ER324186	R CB H SNP FS RDS 1/4W 681J

## 4. ASSEMBLY BLOCK

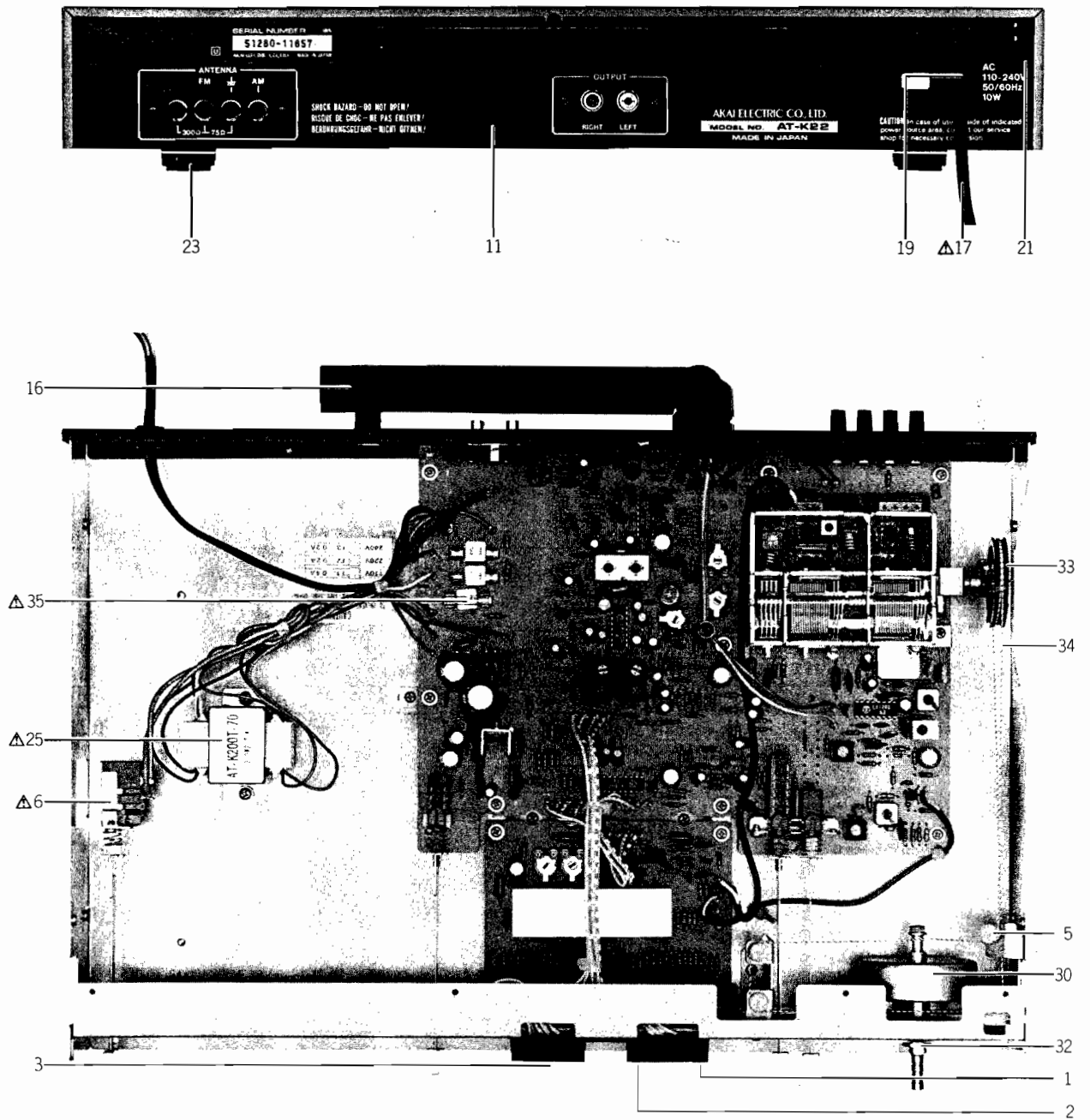

## ASSEMBLY BLOCK

REF. NO.	PARTS NO.	DESCRIPTION
<b>LED P.C BOARD BLOCK</b>		
4-1	ED322247	D LED SLP-151D RED
4-2	ED322215	D LED SLP-251D GRN
4-3	ED322184	D LED SLP-152D RED
4-4x	ZW698308	RV NYL 30x055 BL
<b>ROLLER ANGLE (A) BLOCK</b>		
4-5	MR308836	PULLEY
<b>POWER SW BLOCK</b>		
4-6	ES310839	△ SW PUSH SDG1 P-E 01-1 E (U/T CEE,SAA)
4-7x	ES665875	△ SW PUSH SDG1P-J 01-1 UC (CSA, AAL)
4-8x	EC320548	△ C CE V F 103Z 250AC (U/T)
4-9x	EC314688	△ C CE V FZ 103P 125AC (CSA, AAL)
4-10x	EC330307	△ C MMY V ECQUF 472M 250AC (CEE, SAA)
<b>REAR PANEL BLOCK</b>		
4-11	SP329253A	REAR PANEL AT-K22 (U)
4-12x	SP329253B	REAR PANEL AT-K22 (C)
4-13x	SP329253C	REAR PANEL AT-K22 (A)
4-14x	SP329253D	REAR PANEL AT-K22 (E)
4-15x	SP329253E	REAR PANEL AT-K22 (B,S)
4-16	EE200184	ANT BAR AT-K200 MW
4-17	EW306428	△ AC CORD 2 CORES KP-205A, VFF UCJ (U/T)
4-18x	EW305691	△ AC CORD 2 CORES KP-8, SPT-1 UC (CSA,AAL)
4-19	EZ631945	△ STRAIN RELIEF SR-4N-4 (U/T CSA,AAL)
4-20x	EJ301513	△ SOCKET INLET S-I6453 E 2P (CEE, SAA)
4-21	ZS319460	T2BR 30x06 STL BZN PROJEC- TION
4-22x	ZS325495	T2BR 30x06 STL CMT
4-23	SA311742	ROUND FOOT
4-24x	ZS565942	T2PAN40x08STL CMT
4-25	BT328842	△ TRANS POWER AT-K200T-70 (U/T)
4-26x	BT328843	△ TRANS POWER AT-K200T-30 (CSA, AAL)
4-27x	BT238844	△ TRANS POWER AT-K200T-40 (CEE)
4-28x	BT328845	△ TRANS POWER AT-200T-50 (SAA)
4-29x	ZW698308	RV NYL30x055 BL
4-30	TA328846	TUNING WHEEL
4-31x	ZW436026	PW92x150x050STL CMT
4-32	ZW554624	E JACK NUT SPCC N13
4-33	TA322250	DIAL WHEEL ASSY
4-34	TA307160	DIAL STRING TK-1064 D0.5
4-35	EF309389	△ FUSE TSC A 250V 0.40A (U/T)
4-36x	EF308933	△ FUSE TSC A 250V 0.20A (U/T)
4-37x	EF308848	△ FUSE TSC 125V 0.40A (CSA, AAL)
4-38x	EF300590	△ FUSE EAWK T 250V 0.40A (CEE, SAA)
4-39x	EW315767	△ AC CORD 2 CORES KP-419C/ KS-15 E (CEE)
4-40x	EW322401	△ AC CORD 2 CORES KP-560/ S-15 S (SAA)



## 5. FINAL ASSEMBLY BLOCK

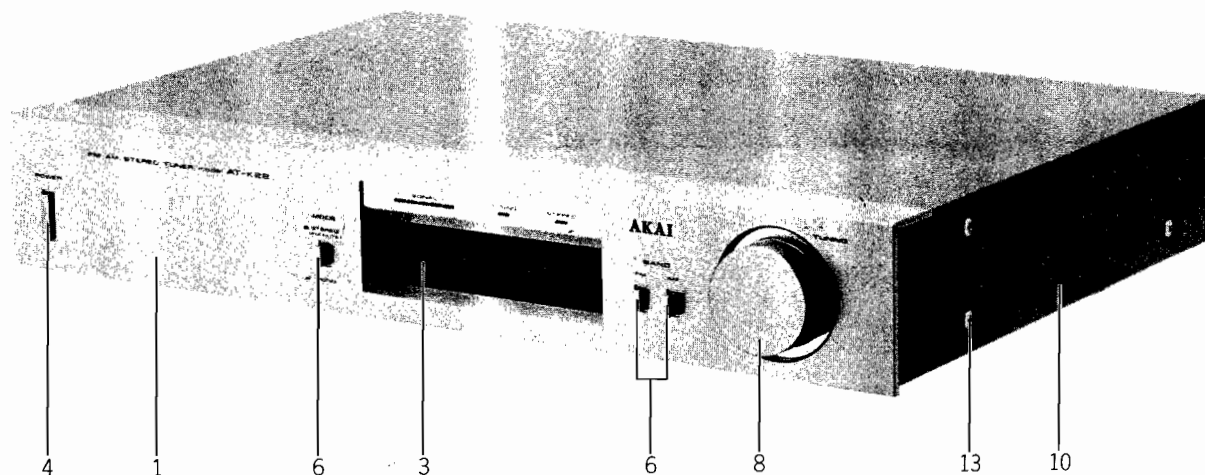

### FINAL ASSEMBLY BLOCK

REF. NO.	PARTS NO.	DESCRIPTION
5-1	BDB329241A	FRONT PANEL PART AT-K22
5-2x	BDB329241B	FRONT PANEL PART AT-K22-BL
5-3	TA329251	LED FILTER
5-4	SB316498	BUTTON (B)
5-5x	SB316499	BUTTON (B-BL)
5-6	SB329581A	BUTTON
5-7x	SB329581B	BUTTON (BL)
5-8	SK322207	TUNING KNOB (A)
5-9x	SK322208	TUNING KNOB (A-BL)
5-10	BC322209	UPPER COVER (A)(U/T,CSA,CEE, SAA)
5-11x	BC322212	UPPER COVER (B) (AAL)
5-12x	BC322210	UPPER COVER (A-BL)
5-13	ZS322570	ST BID40x08STL NI3
5-14x	ZS3222580	ST BID40x08STL BNI (AAL,BL)
5-15x	ZS319460	T2BR30x06STL BZN PROJECTION
5-16x	ZW305013	RV POP32

# IV. MODEL AT-K22L

\*The composite parts of Model AT-K22L, except for those which have been changed as per the List below, are identical to those of Model AT-K22 Therefore, when ordering parts for this tape deck, please utilize Model AT-K22 Parts List.

## 1. TUNER P.C BOARD (ATKZ-48A) BLOCK

REF. NO.	PARTS NO.	DESCRIPTION
1-1	BAA3009C030A	PC TUNER BLK AT-K22L (CEE,UK)
1-SW3	ES200829	SW PUSH SUF22 2 THROW
1-T5	EO201252	COIL OSC2 RNR-44498N 600 UH
1-C68	EC201253	C STY V F05 CQF09 161J 50DC

## 2. ANTENA SW P.C BOARD (ATD-2063) BLOCK

REF. NO.	PARTS NO.	DESCRIPTION
2-SW1	ES319168	SW PUSH SUF12 2-04-02N
2-L1	EO485278	COIL FIX1 FL05H 220μH K
2-T1	EO324453	COIL VARI2 RUR-44313N
2-VC1,2	EC616342	C S-FIX H CTY122D33 1.5-16

## 3. POWER SW BLOCK

REF. NO.	PARTS NO.	DESCRIPTION
3-1	ES310839	△ SW PUSH SDG1 P-E 01-1 E
3-2	EC330307	△ C MMY V ECQUF 472M 250AC

## 4. REAR PANEL BLOCK

REF. NO.	PARTS NO.	DESCRIPTION
4-1	SP329253F	REAR PANEL AT-K22L (E)
4-2	SP329253G	REAR PANEL AT-K22L (B)
4-3	EE200810	ANT BAR AT-K22L LW/MW
4-4	EJ301513	△ SOCKET INLET S-16453 E 2P
4-5	SK607127	PUSH KNOB (A)

## 5. FINAL ASSEMBLY BLOCK

REF. NO.	PARTS NO.	DESCRIPTION
5-1	BT330411	△ TRANS POWER AT-K22LT-40 (CEE)
5-2	BT330413	△ TRANS POWER AT-K22LT-50 (UK)
5-3	EF300590	△ FUSE EAWK T 250V 0.40A (CEE,UK)
5-4	BDB329241C	FRONT PANEL PART AT-K22L
5-5	BDB329241D	FRONT PANEL PART AT-K22L-BL
5-6	TA329251	LED FILTER
5-7	EW315767	△ AC CORD 2 CORES KP-419C/ KS-15 E (CEE)
5-8	EW302995	△ AC CORD 2 CORES VM-0112 B (UK)

## V. MODEL AM-U11

### 1. RECOMMENDED SPARE PARTS LIST

Because, if the parts listed below are on hand, almost any repair can be accomplished, we suggest that you stock these Recommended Spare Parts Items.

Parts No.	Description	Notes
BT704530	△ TRANS POWER PT-376 (B)	UK, SAA
BT704528	△ TRANS POWER PT-376 (C,A)	CSA, AAL
BT704529	△ TRANS POWER PT-376 (E)	CEE
BT704527	△ TRANS POWER PT-376 (U)	U/T
ED379855	D GERMA H 1N60P	
ED322215	D LED SLP-251D GRN	
ED624903	D SILICON H 1S2473	
ED704547	D SILICON KBPC802	
ED328486	D ZENER H HZ15 3	
ED313623	D ZENER H HZ22 3	
EF300603	△ FUSE FST3100 T 250V 0.8A	CEE, UK, SAA
EF301160	△ FUSE FST3100 T 250V 2A	CEE, UK, SAA
EF300607	△ FUSE FST3100 T 250V 3.15A	CEE, UK, SAA
EF704513	△ FUSE SS-2 250V 0.8A	CSA, AAL
EF704516	△ FUSE 125V 3.5A	CSA, AAL
EF704512	△ FUSE 120V 0.8A	U/T
EF704519	△ FUSE 250V 2.5A	U/T
EF704515	△ FUSE 250V 3.5A	U/T
EF704521	△ FUSE 250V 3A	CSA, AAL
EI213390	IC NJM4558D	
EI704498	IC STK461	
EJ704536	△ AC OUTLET UL	U/T, CSA, ALL
EJ704505	HEADPHONE JACK S-G2305	
EM704509	METER (BL) MG-108U	
EM704508	METER MG-108U	
ER704555	△ R FUSE 1/4W 101	
ER704523	△ SPARK KILLER CR-3	U/T
ER704525	△ SPARK KILLER ECQ-U1A 103ME	CSA, AAL
ER704526	△ SPARK KILLER PME265MB51	CEE, UK, SAA
ES310839	△ SW PUSH SDG1P-E 01-1 E	U/T
ES665875	△ SW PUSH SDG1P-J 01-1 UC	CSA, AAL
ES665807	△ SW PUSH SDG5P-E 02 E	CEE, UK, SAA
ES702223	SW PUSH R2100469	
ES702226	SW PUSH R2100470	
ES702225	SW PUSH R2100475	
ET223446	TR 2SC1571NP G,H	
EV305635	R S-FIX H D8 3P 502	
EV701956	VR ROTARY 16P20 15A104	
EV701955	VR ROTARY 16P22 B254Z254	

## 2. AMP P.C BOARD BLOCK

REF. NO.	PARTS NO.	DESCRIPTION
2-IC1	EI213390	IC NJM4558D
2-IC2	EI704498	IC STK461
2-TR101	ET223446	TR 2SC1571NP G,H
2-D101,102	ED379855	D GERMA HA 1N60P
2-D103	ED624903	D SILICON H 1S2473
2-D305	ED624903	D SILICON H 1S2473
2-D310,311	ED328486	D ZENER H HZ15 3
2-D312	ED313623	D ZENER H HZ22 3
2-D313	ED704547	D SILICON KBPC802
2-VR101	EV305635	R S-FIX H D8 3P 502
2-R133	ER704556	R OMF 3W R33
2-R134	ER704557	R OMF 2W 4R7
2-R139	ER558213	R OMF H 1W 181J
2-R307,308	ER453565	R OMF H 2W 122J
2-R310	ER490814	R OMF H 2W 681J
2-R311	ER704555	△ R FUSE 1/4W 101
2-C308,309	EC310846	C EC V UNB 472M 35DC
2-F1,2	EF704515	△ FUSE 250V 3.5A (U/T)
2-F1,2	EF704516	△ FUSE 125V 3.5A (CSA, AAL)
2-F1,2	EF300607	△ FUSE FST3100 T 250V 3.15A (CEE, UK, SAA)
2-F3	EF704512	△ FUSE 250V 0.8A (U/T)
2-F3	EF704513	△ FUSE SS-2 250V 0.8A (CSA, AAL)
2-F3	EF300603	△ FUSE FST3100 T 250V 0.8A (CEE,UK, SAA)
2-F4,5	EF704519	△ FUSE 250V 2.5A (U/T)
2-F4,5	EF704521	△ FUSE 250V 3A (CSA,AAL)
2-F4,5	EF301160	△ FUSE FST3100 T 250V 2A (CEE, UK, SAA)

### 3. ASSEMBLY BLOCK

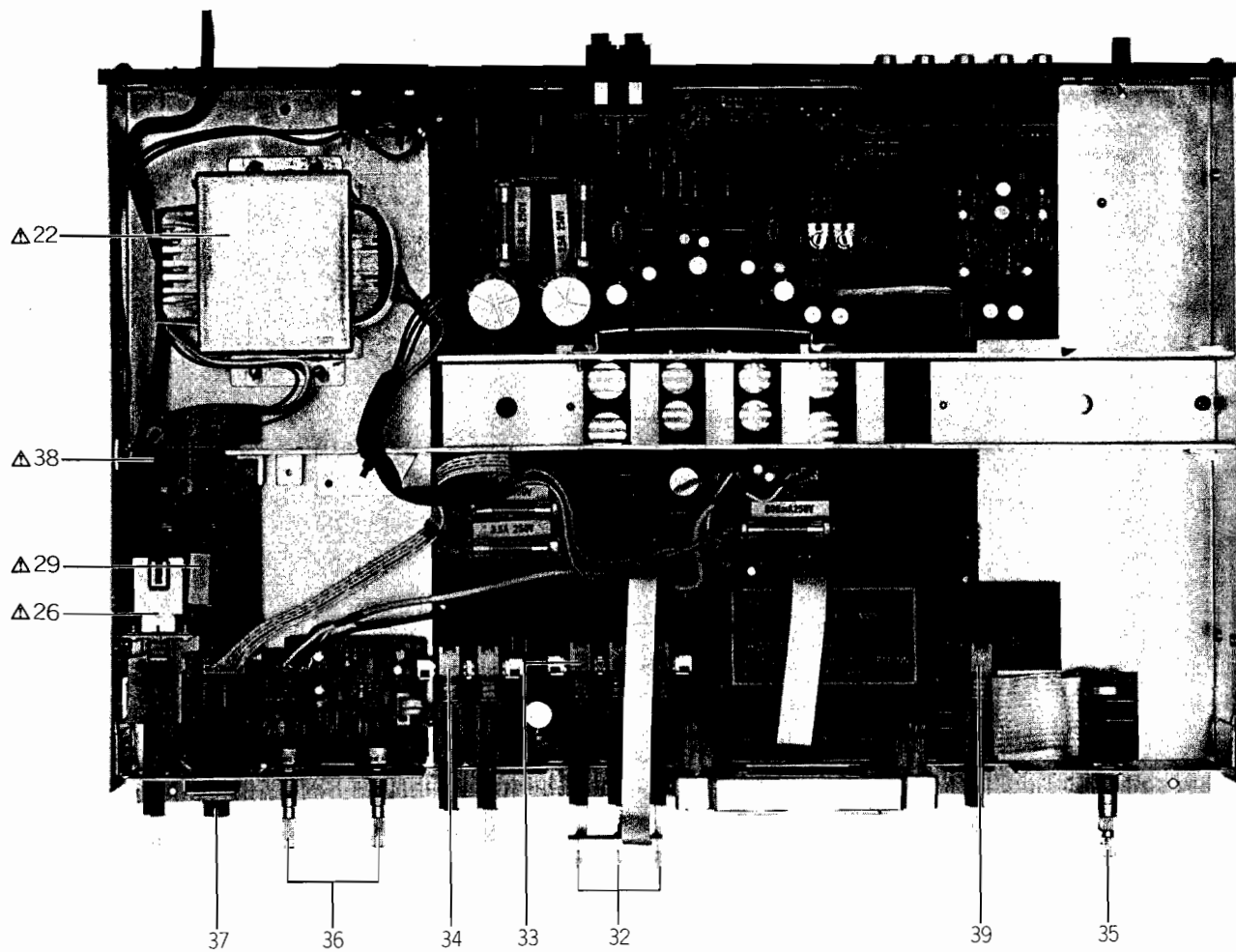
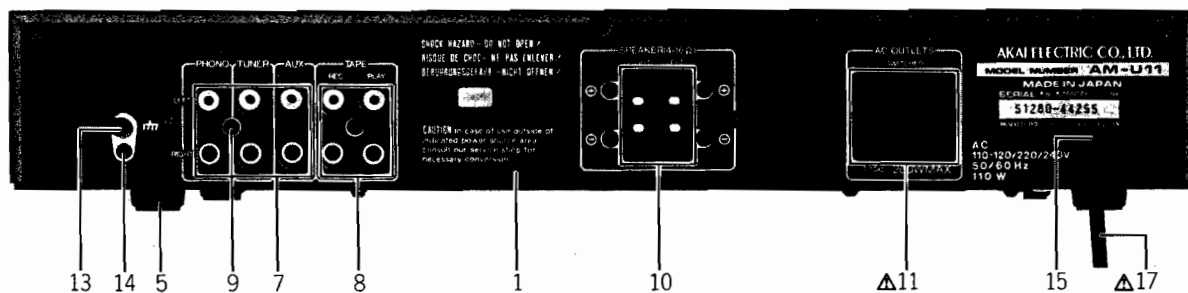

## ASSEMBLY BLOCK

REF. NO.	PARTS NO.	DESCRIPTION
3-1	SP701946	PANEL REAR AM-U11 (U)(U/T)
3-2x	SP701947	PANEL REAR AM-U11 (C,A) (CSA,AAL)
3-3x	SP701944	PANEL REAR AM-U11 (E)(CEE)
3-4x	SP701945	PANEL REAR AM-U11 (B,S) (UK,SAA)
3-5	SA704495	FOOT T-G
3-6x	ZS308895	ST PAN 30x08STL CMT
3-7	EJ704499	PIN JACK 6P RCA1796 P269
3-8	EJ704500	PIN JACK 4P RCA1794 P268
3-9	ZS463353	T2BR 30x08STL BNI
3-10	EJ704506	SPEAKER J S-Q2367 4P
3-11	EJ704536	△ AC OUTLET UL (U/T, CSA,AAL)
3-12x	EJ704511	DIN JACK 5P 2-01-0128-20 (CEE,UK,SAA)
3-13	EJ704535	GND TERMINAL
3-14	ZS447761	T2BR 30x06STL BNI
3-15	EJ704538	CORD BUSH SR 3P-4 (U/T,CSA AAL)
3-16x	EZ631945	STAIN RELIEF SR-4N-4 (CEE,UK SAA)
3-17	EW704531	△ POWER CORD KP-205A U (U/T)
3-18x	EW704532	△ POWER CORD KP-10 U,C (CSA, AAL)
3-19x	EW704533	△ POWER CORD KP-419C C (CEE)
3-20x	EW704534	△ POWER CORD GTBS-2F B (UK)
3-21x	EW704554	△ POWER CORD KP-560 S (SAA)
3-22	BT704527	△ TRANS POWER PT-376 (U)(U/T)
3-23x	BT704528	△ TRANS POWER PT-376 (CA) (CSA,AAL)
3-24x	BT704529	△ TRANS POWER PT-376 (E) (CEE)
3-25x	BT704530	△ TRANS POWER PT-376 (B) (UK, SAA)
3-26	ES310839	△ SW PUSH SDG1P-E 01-1 E (U/T)
3-27x	ES665875	△ SW PUSH SDG1P-J 01-1 UC (CSA, AAL)
3-28x	ES665807	△ SW PUSH SDG5P-E 02 E (CEE, UK, SAA)
3-29	ER704523	△ SPARK KILLER CR-3 (U/T)
3-30x	ER704525	△ SPARK KILLER ECQ-U1A 103 ME (CSA,AAL)
3-31x	ER704526	△ SPARK KILLER PME265 MB51 (CEE, UK,SAA)
3-32	ED322215	D LED SLP-251D GRN
3-33	ES702223	SW PUSH R2100469
3-34	ES702226	SW PUSH R2100470
3-35	EV701955	VR ROTARY 16P22 B254Z254
3-36	EV701956	VR ROTARY 16P20 15A104
3-37	EJ704505	HEADPHONE JACK S-G 2305
3-38	EJ704539	△ VOLTAGE CHANGE WIRE (U/T)
3-39	ES702225	SW PUSH R2100475

#### 4. FINAL ASSEMBLY BLOCK

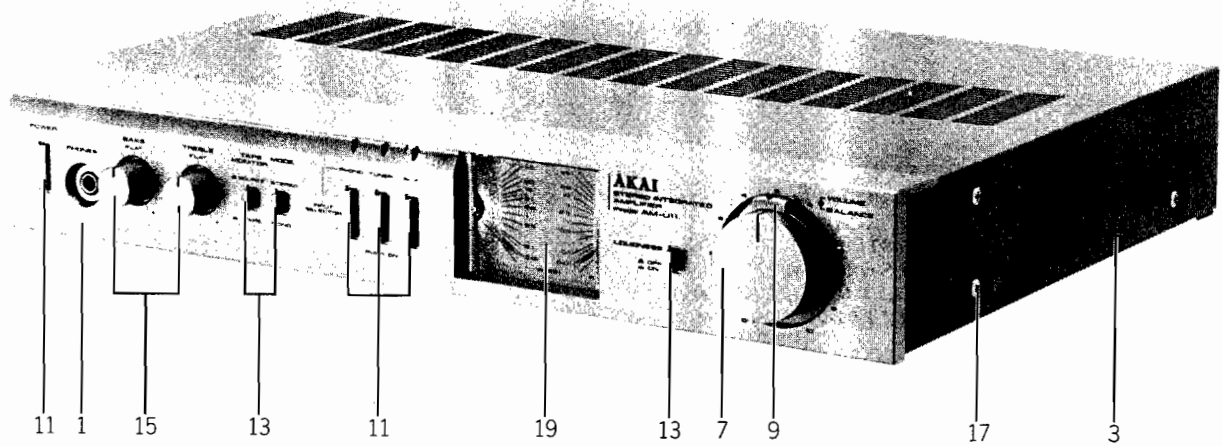

#### FINAL ASSEMBLY BLOCK

REF. NO.	PARTS NO.	DESCRIPTION
4-1	SP701939	PANEL FRONT AM-U11
4-2x	SP701940	PANEL FRONT AM-U11-BL
4-3	SP704489	COVER UPPER (U/T,AAL,CEE, UK,SAA)
4-4x	SP701948	COVER UPPER (CSA)
4-5x	SP704490	COVER UPPER (BL) (U/T,AAL, CEE,UK,SAA)
4-6x	SP701949	COVER UPPER (BL) (CSA)
4-7	SK704550	DOUBLE KNOB (UPPER)
4-8x	SK704549	DOUBLE KNOB (UPPER-BL)
4-9	SK704552	DOUBLE KNOB (LOWER)
4-10x	SK704551	DOUBLE KNOB (LOWER-BL)
4-11	SB316498	BUTTON (B)
4-12x	SB316499	BUTTON (B-BL)
4-13	SK701941	KNOB (B)
4-14x	SK701942	KNOB (B-BL)
4-15	SK704541	SINGLE KNOB
4-16x	SK704540	SINGLE KNOB (BL)
4-17	ZS322570	ST BID40x08STL NI3
4-18x	ZS322580	ST BID40x08STL BNI
4-19	EM704508	METER MG-108U
4-20x	EM704509	METER (BL) MG-108U

## VI. MODEL AM-U22

### 1. RECOMMENDED SPARE PARTS LIST

Because, if the parts listed below are on hand, almost any repair can be accomplished, we suggest that you stock these Recommended Spare Parts Items.

Parts No.	Description	Notes
BT329606	△ TRANS POWER AM-U22T-20	AAL
BT329607	△ TRANS POWER AM-U22T-30	CSA
BT329608	△ TRANS POWER AM-U22T-40	CEE
BT329609	△ TRANS POWER AM-U22T-50	UK, SAA
BT329605	△ TRANS POWER AM-U22T-70	U/T
ED322772	D LED SLP-155D-01 RED	
ED200213	D SILICON DBA40C-K15 200/2.6A	
ED300924	D SILICON GP08D 200/0.8A	
ED200469	D SILICON H DS448 FA1 F10	
EF602550	△ FUSE SEMKO T 250V 1.25A	CEE, UK, SAA
EF602550	△ FUSE SEMKO T 250V 1.25A	CEE, UK, SAA
EF623125	△ FUSE SEMKO T 250V 2.5A	CEE, UK, SAA
EF690996	△ FUSE SEMKO T 250V 4A	CEE, UK, SAA
EF306949	△ FUSE TSC A 250V 1.25A	U/T
EF306951	△ FUSE TSC A 250V 2.5A	U/T
EF306950	△ FUSE TSC A 250V 2A	U/T
EF306952	△ FUSE TSC A 250V 4A	U/T
EF306956	△ FUSE TSC 125V 2.5A	CSA, AAL
EF306954	△ FUSE TSC 125V 2A	CSA, AAL
EF306957	△ FUSE TSC 125V 4A	CSA, AAL
EF306957	△ FUSE TSC 125V 4A	CSA, AAL
EI697871	IC LA3122S	
EI329612	IC LB1409	
EI329611	IC STK463SLY	
EO650823	COIL FIX 2 2.2UH	
ES310839	△ SW PUSH SDG1P-E 01-1 E	U/T, CEE, UK, SAA
ES665875	△ SW PUSH SDG1P-J 01-1 UC	CSA, AAL
ES329615	SW PUSH SUF84 8-THROW	
ET293253	TR 2SC1627 O, Y	
EV315416	R S-FIX H D8 3P 103	
EV324345	VR ROTARY 16P20x1S 15C104	
EV329572	VR ROTARY 16P22x0A 1Z254 3BM254	



## 2. MAIN AMP P.C BOARD (AMUZ-16A/23A/32A) BLOCK

REF. NO.	PARTS NO.	DESCRIPTION
2-1	BAA2005A090A	MAIN AMP PC BLK AM-U22(U) (U/T)
2-2	BAA2005A090B	MAIN AMP PC BLK AM-U22(C) (CSA, AAL)
2-3	BAA2005A090C	MAIN AMP PC BLK AM-U22(E) (CEE,UK, SAA)
2-IC1	EI697871	IC LA3122S
2-IC2	EI329612	IC LB1409
2-IC3	EI329611	IC STK463SLY
2-TR1	ET293253	△ TR 2SC1627 O,Y
2-D1	ED200213	△ D SILICON DBA40C-K15 200/2.6A
2-D2	ED300924	△ D SILICON GP08D 200/0.8A
2-D3 to 6	ED200469	D SILICON H DS448 FA1 F10
2-J4,5	EJ293365	PIN J T5703-E P 4P
2-J6	EJ293376	PIN J T5704-E P 6P
2-SW1	ES329615	SW PUSH SUF84 8-THROW
2-VR1, 2	EV324345	VR ROTARY 16P20x1S 15C104
2-VR3	EV315416	R S-FIX H D8 3P 103
2-L1	EO650823	COIL FIX 2 2.2UH
2-R8	ER325269	△ R CB H SNP FS RDS 1/4W 222J
2-R19	ER323074	△ R CB H SNP FS RDS 1/4W 102J
2-R20	ER329616	△ R CT P F09 PLATE 3W R47K
2-R21	ER322591	△ R CB H SNP FS RDS 1/4W 101J
2-R22	ER308875	△ R CB H SNP FS RDS 1/2W 100J
2-R52	ER200939	△ R CB H SNP FS RDS 1/4W 181J
2-C16	EC313532	C EC V F05 NP 04D 1ROM 50.0DC
2-C31	EC316190	C EC V F05 NP 04D 470M 10DC
2-C38,39	EC320307	C EC V SNP VN 682 40DC
2-C47	EC326583	C MMY V CUT CF921 473K 400DC

### 3. ASSEMBLY BLOCK

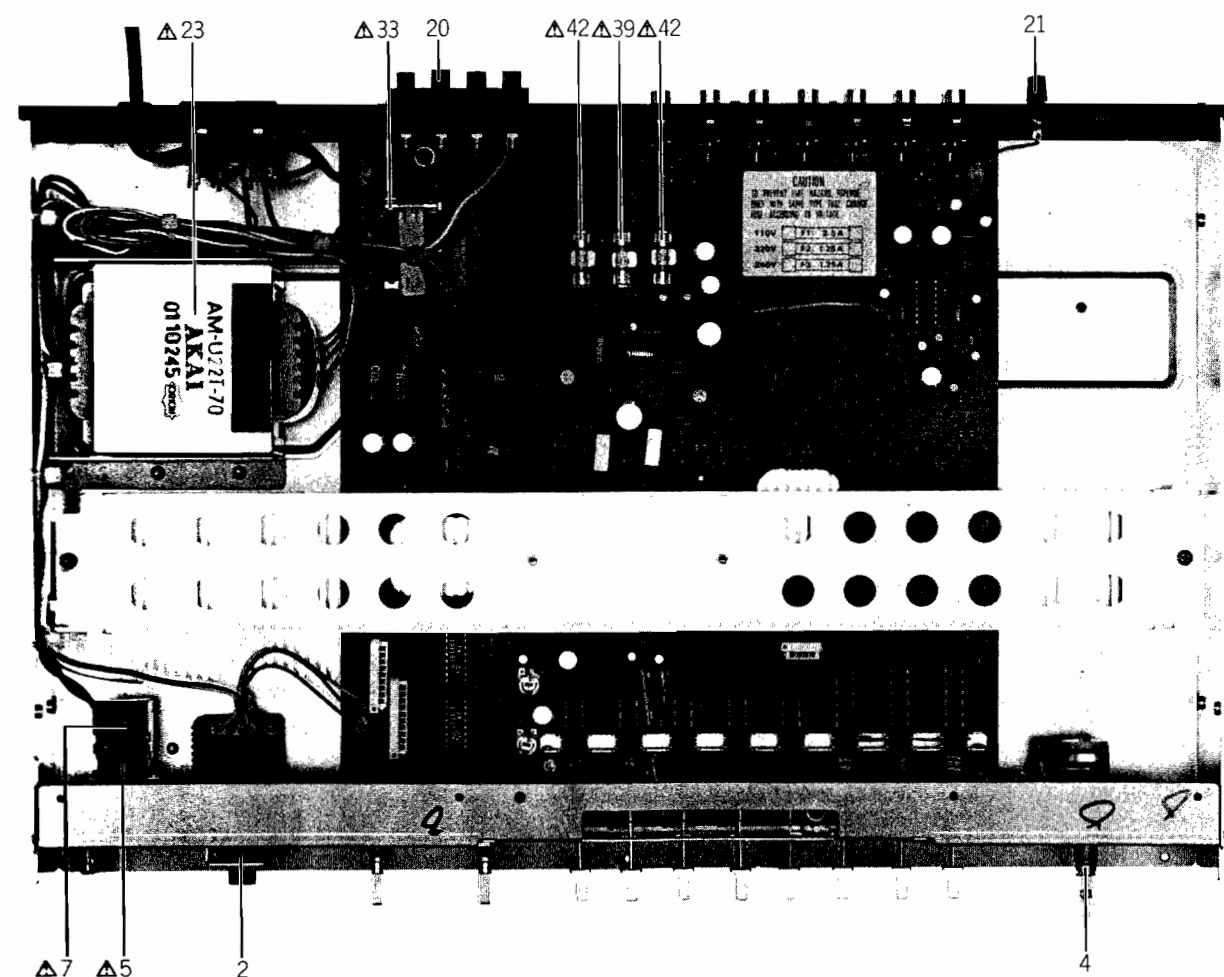
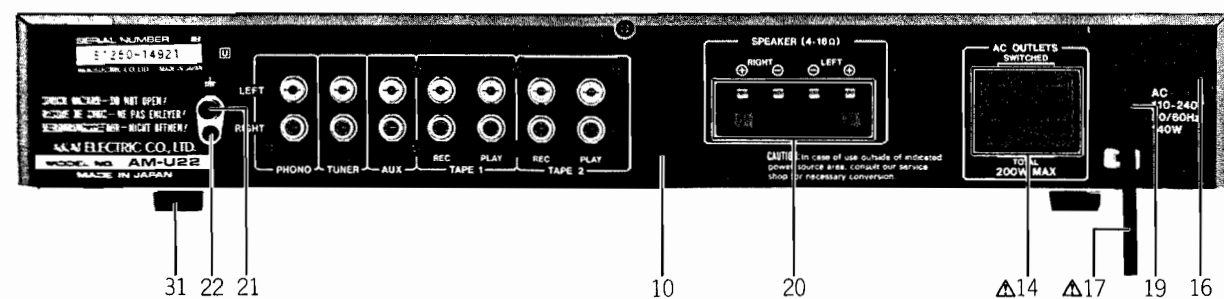

### ASSEMBLY BLOCK

REF. NO.	PARTS NO.	DESCRIPTION
3-1x	ED322772	LED (A) P.C BOARD BLOCK D LED SLP-155D-01 RED
3-2	EJ329265	HEADPHONE JACK P.C BOARD BLOCK PHONE J 3P HLJ0315-040 6.3 2C
3-3x	ER308503	R OMF H FS 1W 181J
3-4	EV329572	VOLUME P.C BOARD BLOCK VR ROTARY 16P22x0A 1Z254 3BM254
3-5	ES310839	SW PUSH SDG1P-E 01-1 E (U/T, CEE, UK, SAA)
3-6x	ES665875	SW PUSH SDG1P-J 01-1 UC (CSA, AAL)
3-7	EC320548	C CE V F 103Z 250AC (U/T)
3-8x	EC314688	C CE V FZ 103P 125AC (CSA, AAL)
3-9x	EC330307	C MMY V ECQUF 472M 250AC (CEE, UK, SAA)
3-10	SP329588A	REAR PANEL AM-U22 (U)
3-11x	SP329588B	REAR PANEL AM-U22 (C,A)
3-12x	SP329588C	REAR PANEL AM-U22 (E)
3-13x	SP329588D	REAR PANEL AM-U22 (B,S)
3-14	EZ225145	SOCKET OUTLET S-16468 UC 2x2P (U/T, CSA, AAL)
3-15x	EJ296853	SOCKET INLET CM-3 UC EB 3P (CEE, UK, SAA)
3-16	ZS463353	T2BR 30x08STL BNI
3-17	EW306428	AC CORD 2 CORES KP. 205A, VFF UCJ (U/T)
3-18x	EW305691	AC CORD 2 CORES KP-8, SPT-1 UC (CSA, AAL)
3-19	EZ631945	STRAIN RELIEF SR-4N-4 (U/T, CSA, AAL)
3-20	EJ322582	TERMINAL PUSH S-Q2370 S 4P
3-21	EJ329610	TERMINAL W/SCREW UB-0067 L 1P
3-22	ZS447761	T2BR30x06STL BNI
3-23	BT329605	TRANS POWER AM-22T-70 (U/T)
3-24x	BT329607	TRANS POWER AM-U22T-30 (CSA)
3-25x	BT329606	TRANS POWER AM-U22T-20 (AAL)
3-26x	BT329608	TRANS POWER AM-U22T-40 (CEE)
3-27x	BT329609	TRANS POWER AM-U22T-50 (UK, SAA)
3-28x	ZS319460	T2BR30x06STL BZN PROJEC- TION
3-29x	ZS325495	T2BR30x06STL CMT
3-30x	ZS522865	T2BR30x12STL BNI
3-31	SA311742	ROUND FOOT
3-32x	ZS304022	ST PAN 40x06STL CMT
3-33	EF306951	FUSE TSC A 250A 2.5A (U/T)
3-34x	EF306956	FUSE TSC 125V 2.50A (CSA, AAL)
3-35x	EF602550	FUSE SEMKO T250V 1.25A (CEE, UK, SAA)
3-36x	EF306949	FUSE TSC A 250V 1.25A (U/T)
3-37x	EF306957	FUSE TSC 125V 4.00A (CSA, AAL)
3-38x	EF690996	FUSE SEMKO T 250V 4.00A (CEE, UK, SAA)
3-39	EF306952	FUSE TSC A 250V 4.00A (U/T)
3-40x	EF306957	FUSE TSC 125V 4.00A (CSA, AAL)

REF. NO.	PARTS NO.	DESCRIPTION
3-41x	EF623125	FUSE SEMKO T250V 2.50A (CEE, UK, SAA)
3-42	EF306950	FUSE TSC A 250V 2.00A (U/T)
3-43x	EF306954	FUSE TSC 125V 2.00A (CSA, AAL)
3-44x	EF602550	FUSE SEMKO T 250V 1.25A (CEE, UK, SAA)

#### 4. FINAL ASSEMBLY BLOCK

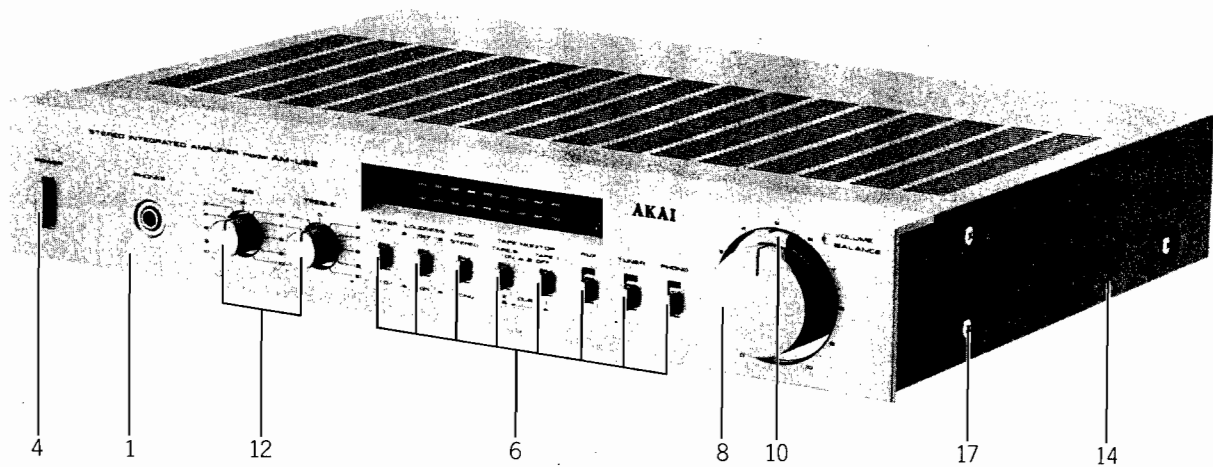

#### FINAL ASSEMBLY BLOCK

REF. NO.	PARTS NO.	DESCRIPTION
4-1	SPB329595A	FRONT PANEL AM-U22 PART
4-2x	SPB329595B	FRONT PANEL AM-U22-BL PART
4-3x	TA329604	PLATE
4-4	SB316498	BUTTON (B)
4-5x	SB316499	BUTTON (B-BL)
4-6	SB329581A	BUTTON
4-7x	SB329581B	BUTTON (BL)
4-8	SK200956	DOUBLE KNOB (UPPER2)
4-9x	SK200958	DOUBLE KNOB (UPPER2-BL)
4-10	SK704552	DOUBLE KNOB (LOWER)
4-11x	SK704551	DOUBLE KNOB (LOWER-BL)
4-12	SK329583A	KNOB (A)
4-13x	SK329583B	KNOB (A-BL)
4-14	SP329585A	UPPER PLATE (A)(U/T,CSA, CEE,UK,SA)
4-15x	SP329585C	UPPER PLATE (B)(AAL)
4-16x	AP329585B	UPPER PLATE (A-BL)
4-17	ZS322570	ST BID40x08STL NI3
4-18x	ZS322580	ST BID40x08STL BNI (ALL,BL)
4-19x	ZS319460	T2BR30x06STL BZN PROJECTION
4-20x	ZW305013	RV POP32

# INDEX

## 1. MODEL AT-K11

Parts No.	Ref. No. & Symbol No.	Parts No.	Ref. No. & Symbol No.	Parts No.	Ref. No. & Symbol No.	Parts No.	Ref. No. & Symbol No.	Parts No.	Ref. No. & Symbol No.
BAA3008A020A	2-1	EF309389	3-34	ER324337	2-R31,32	EW315767	3-39x	TA201961	3-33
BAA3008A020B	2-2	EI293185	2-IC3	ER324480	2-R97,98	EW322401	3-40x	TA322250	3-32
BAA3008A020C	2-3	EI315491	2-IC4	ER328855	2-FL3,4	EZ631945	3-14	TA328846	3-29
BC322209	4-9	EI322248	2-IC1	ER669328	2-R96	MR308836	3-5	ZS319460	3-16
BC322210	4-10x	EI650597	2-IC2	ES201948	2-SW2	MZ307170	3-4	ZS319460	4-14x
BC322212	4-11x	EJ301513	3-15x	ES201979	2-SW1	SA311742	3-18	ZS322570	4-12
BT201517	3-21x	EJ309941	2-TM1	ES310839	3-24	SB316498	4-3	ZS322580	4-13x
BT201518	3-22x	EJ323227	2-J1	ES665875	3-25x	SB316499	4-4x	ZS325495	3-17x
BT201519	3-23x	EO307186	2-T4	ET200506	2-TR5,6	SB329581A	4-5	ZS463094	3-19x
BT201520	3-20	EO328137	2-L1,2	ET316643	2-TR7 to9	SB329581B	4-6x	ZW270191	3-31
EC200928	2-C57,58	EO328854	2-T1	ET316643	2-TR11	SK322207	4-7	ZW305013	4-15x
EC314688	3-27x	ER293398	2-T2	ET316643	2-TR13	SK322208	4-8x	ZW436026	3-30x
EC314996	2-C59	ER307201	2-FL1,2	ET316643	2-TR2 to4	SP201020A	4-1		
EC320548	3-26x	ER307204	2-T3	ET452531	2-TR12	SP201020B	4-2x		
EC328856	2-C76,77	ER324185	2-R83	ET618873	2-TR1	SP329253H	3-6		
EC328862	2-C33	ER324337	2-R13,14	EV427858	2-VR3	SP329253J	3-7x		
EC330307	3-28x	ER324337	2-R56,57	EV499375	2-VR4	SP329253K	3-8x		
EC616342	2-VC1,2	ER324337	2-R73 to75	EV593368	2-VR1,2	SP329253L	3-9x		
ED200469	2-D1 to8	ER324337	2-R65,66	EW305691	3-13x	SP329253M	3-10x		
ED200469	2-D12	ER324337	2-R7,8	EW306428	3-12	TAB201457	3-38		
ED322184	3-3								
ED322215	3-2								
ED322238	2-D10								
ED322247	3-1								
ED323216	2-D9								
EE200184	3-11								
EE322242	2-4								
EF300590	3-37x								
EF308848	3-36x								
EF308933	3-35x								

## 2. MODEL AT-K11L

Parts No.	Ref. No. & Symbol No.	Parts No.	Ref. No. & Symbol No.	Parts No.	Ref. No. & Symbol No.	Parts No.	Ref. No. & Symbol No.	Parts No.	Ref. No. & Symbol No.
BAA3008C020A	1-1	EF300590	4-5	SK607127	3-5				
BT330409	4-1	EJ301513	3-4	SP201020C	4-6				
BT330410	4-2	EO201252	1-T5	SP201020D	4-7				
EC200928	1-C67	EO324453	2-T1	SP329253P	3-1				
EC200930	1-C70	EO48278	2-L1	SP329253Q	3-2				
EC200930	1-C92	ES200829	1-SW3						
EC201253	1-C68	ES310839	4-3						
EC330307	4-4	ES319168	2-SW1						
EC616342	2-VC1,2	EW302995	4-9						
EE200810	3-3	EW315767	4-8						

## 3. MODEL AT-K22

Parts No.	Ref. No. & Symbol No.	Parts No.	Ref. No. & Symbol No.	Parts No.	Ref. No. & Symbol No.	Parts No.	Ref. No. & Symbol No.	Parts No.	Ref. No. & Symbol No.
BAA3009A050A	2-1	ED323216	2-D9	ER324337	2-R7,8	ET618873	2-TR1	SP329253B	4-12x
BAA3009A050B	2-2	ED325080	3-D3	ER324337	2-R13,14	ET618873	3-TR1	SP329253C	4-13x
BAA3009A050C	2-3	EE200184	4-16	ER324337	2-R31,32	EV427858	2-VR3	SP329253D	4-14x
BAA3009A070A	3-1	EE325737	2-4	ER324337	2-R56,57	EV499375	2-VR4	SP329253E	4-15x
BC322209	5-10	EF300590	4-38x	ER324337	2-R73 to75	EV593368	2-VR1,2	TA307160	4-34
BC322210	5-12x	EF308848	4-37x	ER324480	2-R97,98	EV604438	3-VR1,2	TA322250	4-33
BC322212	5-11x	EF308933	4-36x	ER328855	2-FL3,4	EW305691	4-18x	TA328846	4-30
BDB329241A	5-1	EF309389	4-35	ER669328	2-R96	EW306428	4-17	TA329251	5-3
BDB329241B	5-2x	EI293185	2-IC3	ES201948	2-SW2	EW315767	4-39x	ZS319460	4-21
BT238844	4-27x	EI315491	2-IC4	ES201979	2-SW1	EW322401	4-40x	ZS319460	5-15x
BT328842	4-25	EI322248	2-IC1	ES310839	4-6	EZ631945	4-19	ZS322570	5-13
BT328843	4-26x	EI323231	3-x1	ES665875	4-7x	MR308836	4-5	ZS322580	5-14x
BT328845	4-28x	EI328849	3-IC1	ET200506	2-TR5,6	SA311742	4-23	ZS325495	4-22x
EC200928	2-C57,58	EI328850	3-IC2	ET316171	3-TR2	SB316498	5-4	ZS565942	4-24x
EC314688	4-9x	EI650597	2-IC2	ET316643	2-TR2 to4	SB316499	5-5x	ZW305013	5-16x
EC314996	2-C59	EJ301513	4-20x	ET316643	2-TR11	SB329581A	5-6	ZW436026	4-31x
EC320548	4-8x	EJ309941	2-TM1	ET316643	2-TR13	SB329581B	5-7x	ZW554624	4-32
EC328856	2-C76,77	EJ323227	2-J1	ET316643	2-TR7 to9	SK322207	5-8	ZW698308	4-4x
EC328862	2-C33	EM328848	3-IND1	ET323232	2-TR10	SK322208	5-9x	ZW698308	4-29x
EC330307	4-10x	EO307186	2-T4	ET452531	2-TR12	SP329253A	4-11		
EC616342	2-VC1,2	EO328137	2-L1,2						
ED200469	2-D1 to8	EO328137	3-L1 to 3						
ED200469	2-D12	EO328854	2-T1						
ED200469	3-D1,2	ER293398	2-T2						
ED224526	2-D11	ER307201	2-FL1,2						
ED309959	3-D4	ER307204	2-T3						
ED322184	4-3	ER324185	2-R83						
ED322215	4-2	ER324185	3-R35						
ED322238	2-D10	ER324186	3-R38						
ED322247	4-1	ER324337	2-R65,66						

#### 4. MODEL AT-K22L

Parts No.	Ref. No. & Symbol No.	Parts No.	Ref. No. & Symbol No.	Parts No.	Ref. No. & Symbol No.	Parts No.	Ref. No. & Symbol No.	Parts No.	Ref. No. & Symbol No.
BAA3009C030A	1-1	EF300590	5-3	SK607127	4-5				
BDB329241C	5-4	EJ301513	4-4	SP329253F	4-1				
BDB329241D	5-5	EO201252	1-T5	SP329253G	4-2				
BT330411	5-1	EO324453	2-T1	TA329251	5-6				
BT330413	5-2	EO48278	2-L1						
EC201253	1-C68	ES200829	1-SW3						
EC330307	3-2	ES310839	3-1						
EC616342	2-VC1	ES319168	2-SW1						
EC616342	2-VC2	EW302995	5-8						
EE200810	4-3	EW315767	5-7						

#### 5. MODEL AM-U11

Parts No.	Ref. No. & Symbol No.	Parts No.	Ref. No. & Symbol No.	Parts No.	Ref. No. & Symbol No.	Parts No.	Ref. No. & Symbol No.	Part No.	Ref. No. & Symbol No.
BT704527	3-22	EF704521	2-F4,5	ER704555	2-R311	SB316498	4-11	ZS308895	3-6x
BT704528	3-23x	EI213390	2-IC1	ER704556	2-R133	SB316499	4-12x	ZS322570	4-17
BT704529	3-24x	EJ704498	2-IC2	ER704557	2-R134	SK701941	4-13	ZS322580	4-18x
BT704530	3-25x	EJ704499	3-7	ES310839	3-26	SK701942	4-14x	ZS447761	3-14
EC310846	2-C308,309	EJ704500	3-8	ES665807	3-28x	SK704540	4-16x	ZS463353	3-9
ED313623	2-D312	EJ704505	3-37	ES665875	3-27x	SK704541	4-15		
ED322215	3-32	EJ704506	3-10	ES702223	3-33	SK704549	4-8x		
ED328486	2-D310,311	EJ704511	3-12x	ES702225	3-39	SK704550	4-7		
ED379855	2-D101,102	EJ704535	3-13x	ES702226	3-34	SK704551	4-10x		
ED624903	2-D103	EJ704536	3-11	ET223446	2-TR101	SK704552	4-9		
ED624903	2-D305	EJ704538	3-15	EV305635	2-VR101	SP701939	4-1		
ED704547	2-D313	EJ704539	3-38	EV701955	3-35	SP701940	4-2x		
EF300603	2-F3	EM704508	4-19	EV701956	3-36	SP701944	3-3x		
EF300607	2-F1,2	EM704509	4-20x	EW704531	3-17	SP701945	3-4x		
EF301160	2-F4,5	ER453565	2-R307,308	EW704532	3-18x	SP701946	3-1		
EF704512	2-F3	ER490814	2-R310	EW704533	3-19x	SP701947	3-2x		
EF704513	2-F3	ER558213	2-R139	EW704534	3-20x	SP701948	4-4x		
EF704515	2-F1,2	ER704523	3-29	EW704554	3-21x	SP701949	4-6x		
EF704516	2-F1,2	ER704525	3-30x	EZ631945	3-16x	SP704489	4-3		
EF704519	2-F4,5	ER704526	3-31x	SA704495	3-5	SP704490	4-5x		

#### 6. MODEL AM-U22

Parts No.	Ref. No. & Symbol No.	Parts No.	Ref. No. & Symbol No.	Parts No.	Ref. No. & Symbol No.	Parts No.	Ref. No. & Symbol No.	Parts No.	Ref. No. & Symbol No.
BAA2005A090A	2-1	EF306950	3-42	EO650823	2-L1	SB316498	4-4	ZS304022	3-32x
BAA2005A90B	2-2	EF306951	3-33	ER200939	2-R52	SB316499	4-5x	ZS319460	3-28x
BAA2005A090C	2-3	EF306952	3-39	ER308503	3-3x	SB329581A	4-6	ZS319460	4-19x
BT329605	3-23	EF306954	3-43x	ER308875	2-R22	SB329581B	4-7x	ZS322570	4-17
BT329606	3-25x	EF306956	3-34x	ER322591	2-R21	SK200956	4-8	ZS322580	4-18x
BT329607	3-24x	EF306957	3-40x	ER323074	2-R19	SK200958	4-9x	ZS325495	3-29x
BT329608	3-26x	EF306957	3-37x	ER325269	2-R8	SK329583A	4-12	ZS447761	3-22
BT329609	3-27x	EF602550	3-44x	ER329616	2-R20	SK329583B	4-13x	ZS463353	3-16
EC313532	2-C16	EF602550	3-35x	ES310839	3-5	SK704551	4-11x	ZS522865	3-30x
EC314688	3-8x	EF623125	3-41x	ES329615	2-SW1	SK704552	4-10	ZW305013	4-20x
EC316190	2-C31	EF690996	3-38x	ES665875	3-6x	SPB329595A	4-1		
EC320307	2-C38,39	EI329611	2-IC3	ET293253	2-TR1	SPB329595B	4-2x		
EC320548	3-7	EI329612	2-IC2	EV315416	2-VR3	SP329585A	4-14		
EC326583	2-C47	EI697871	2-IC1	EV324345	2-VR1,2	SP329585B	4-16x		
EC330307	3-9x	EJ293365	2-J4,5	EV329572	3-4	SP329585C	4-15x		
ED200213	2-D1	EJ293376	2-J6	EW305691	3-18x	SP329588A	3-10		
ED200469	2-D3 to 6	EJ296853	3-15x	EW306428	3-17	SP329588B	3-11x		
ED300924	2-D2	EJ322582	3-20	EZ225145	3-14	SP329588C	3-12x		
ED322772	3-1x	EJ329265	3-2	EZ631945	3-19	SP329588D	3-13x		
EF306949	3-36x	EJ329610	3-21	SA311742	3-31	TA329604	4-3x		

SECTION 4

# SCHEMATIC DIAGRAM

1. SCHEMATIC DIAGRAM OF ICs
2. AT-K11 NO.162640A SCHEMATIC DIAGRAM
3. AT-K11L NO.162641A SCHEMATIC DIAGRAM
4. AT-K22 NO. 162642A SCHEMATIC DIAGRAM
5. AT-K22L NO. 162643A SCHEMATIC DIAGRAM
6. AM-U11 NO. 1620644A SCHEMATIC DIAGRAM
7. AM-U22 NO. 162645A SCHEMATIC DIAGRAM

AN6552

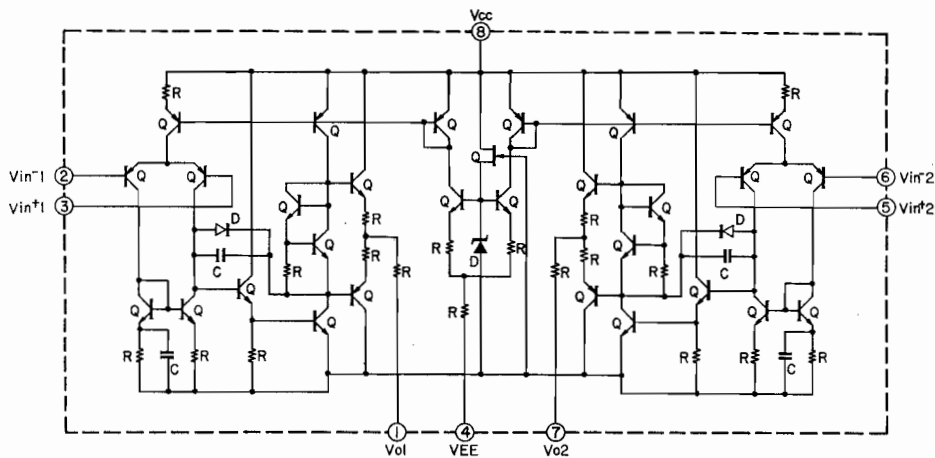

LA1231N

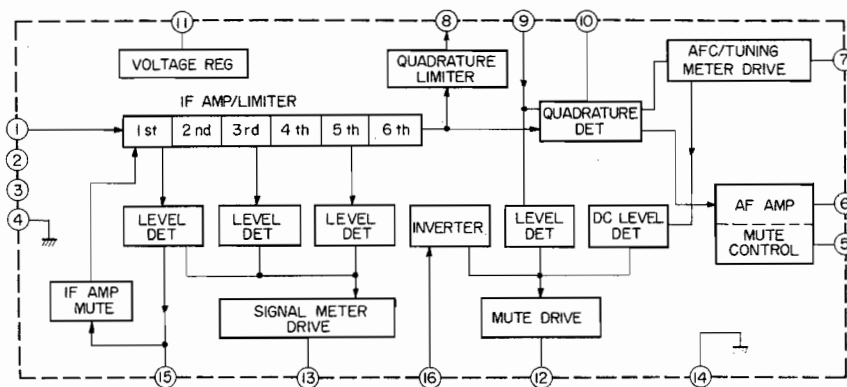

LA1240

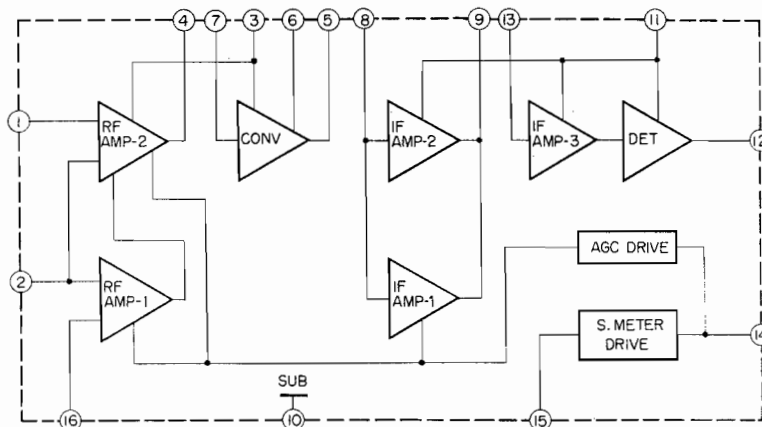

LA3122S

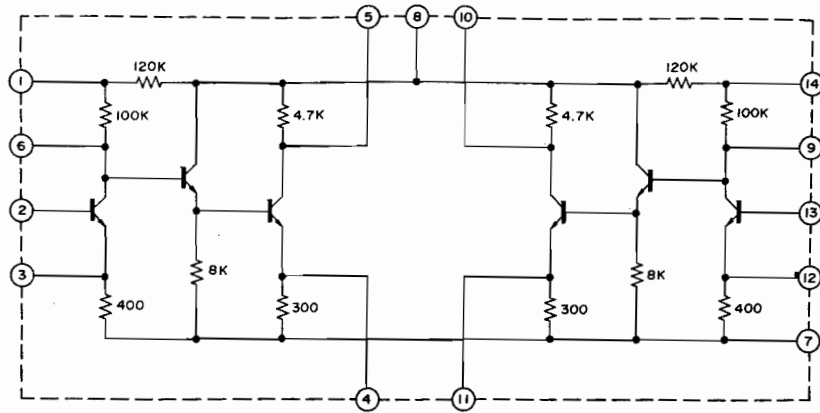

LA3350S

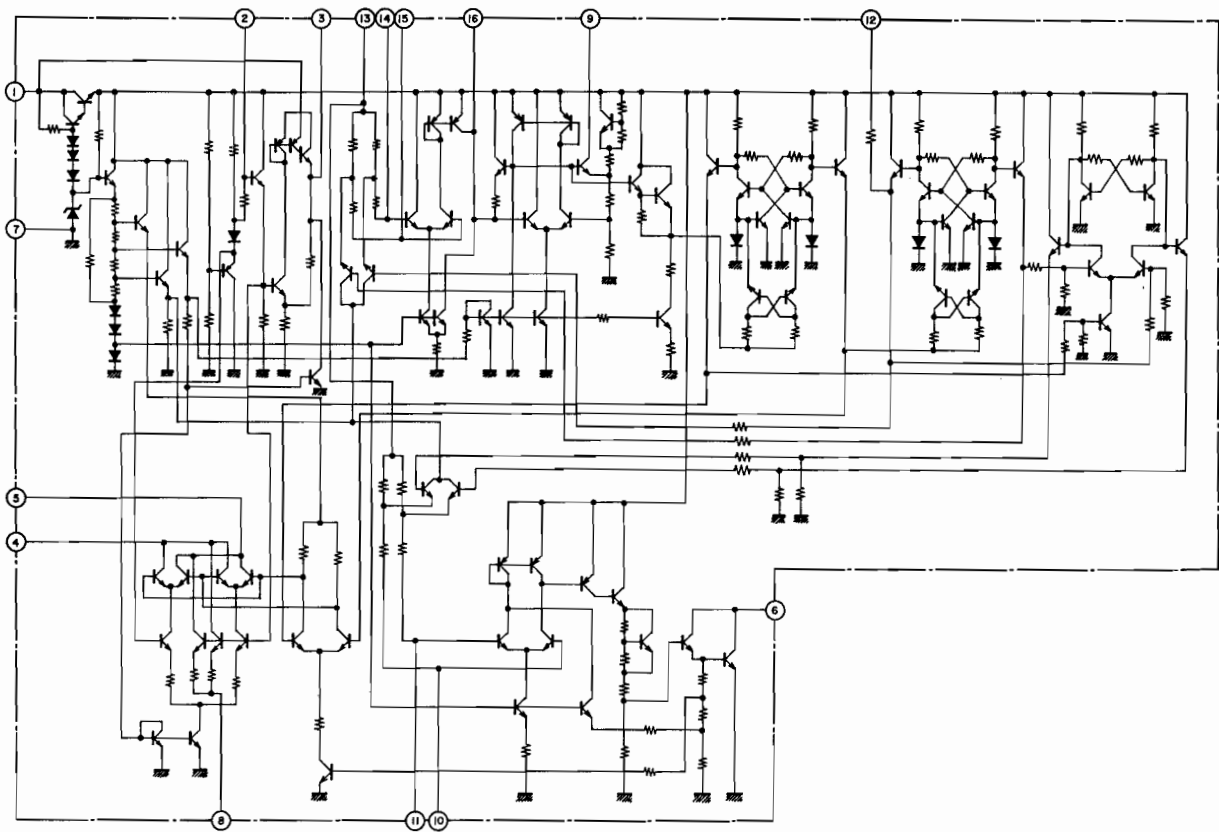

LB1405S

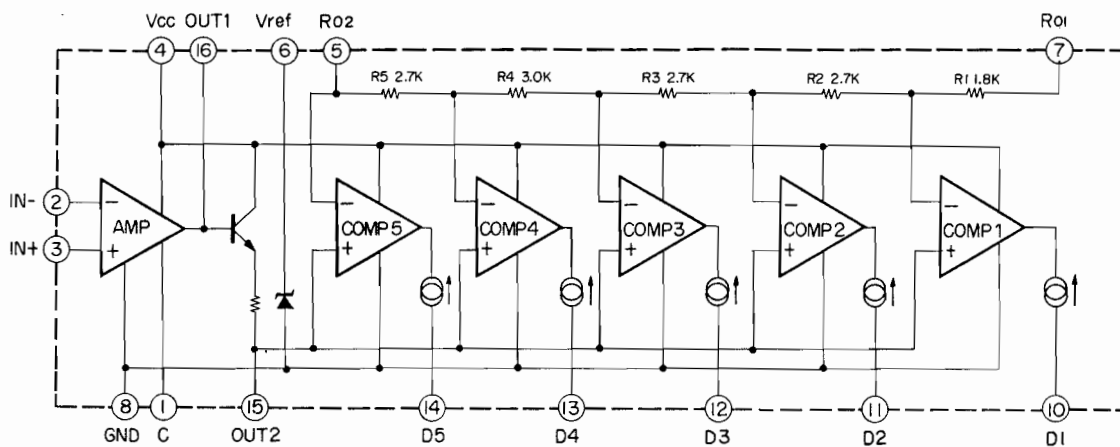

**LB1409**

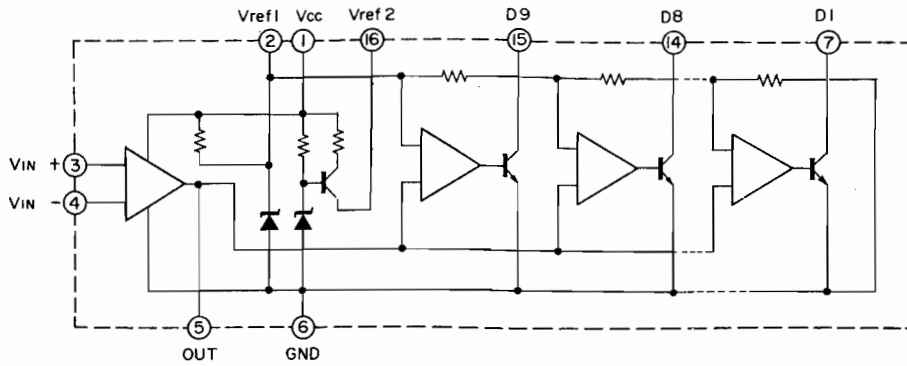

**LC7259**

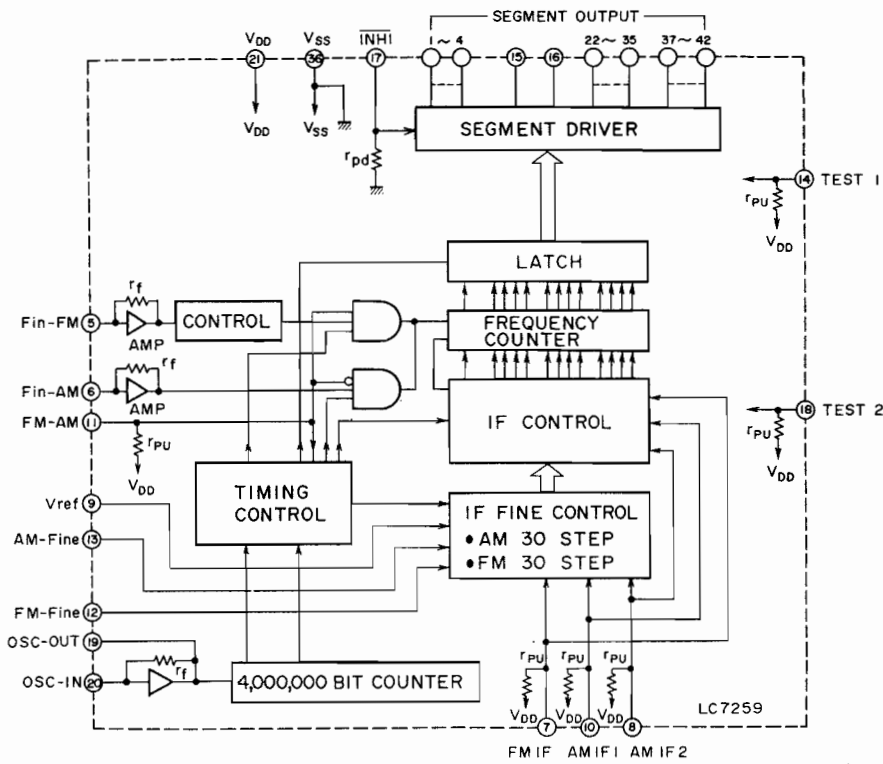

NOTE: rPU is a special-type resistor whose resistance will become the rated value at "H" level, and high at "L" level.

**M54459L**

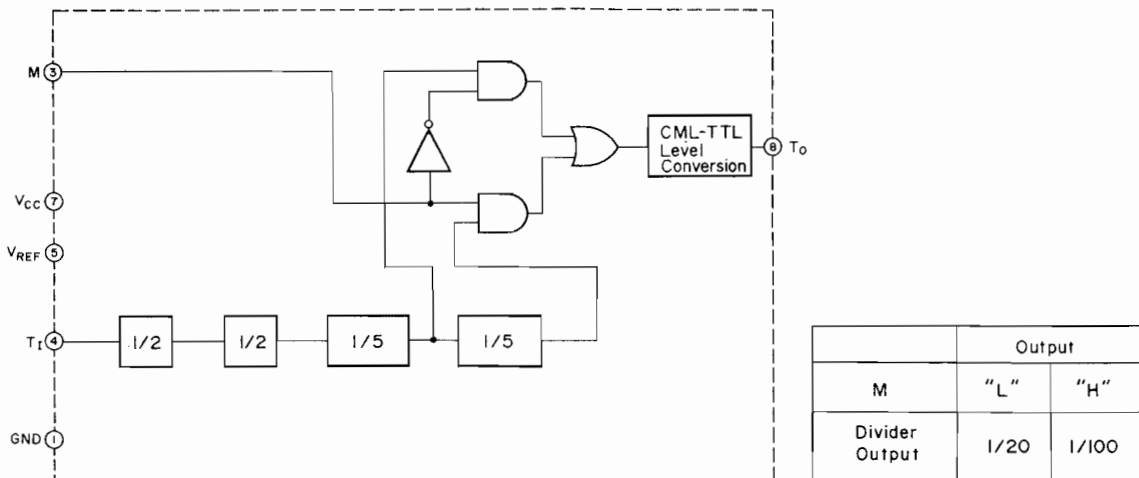



# STK461

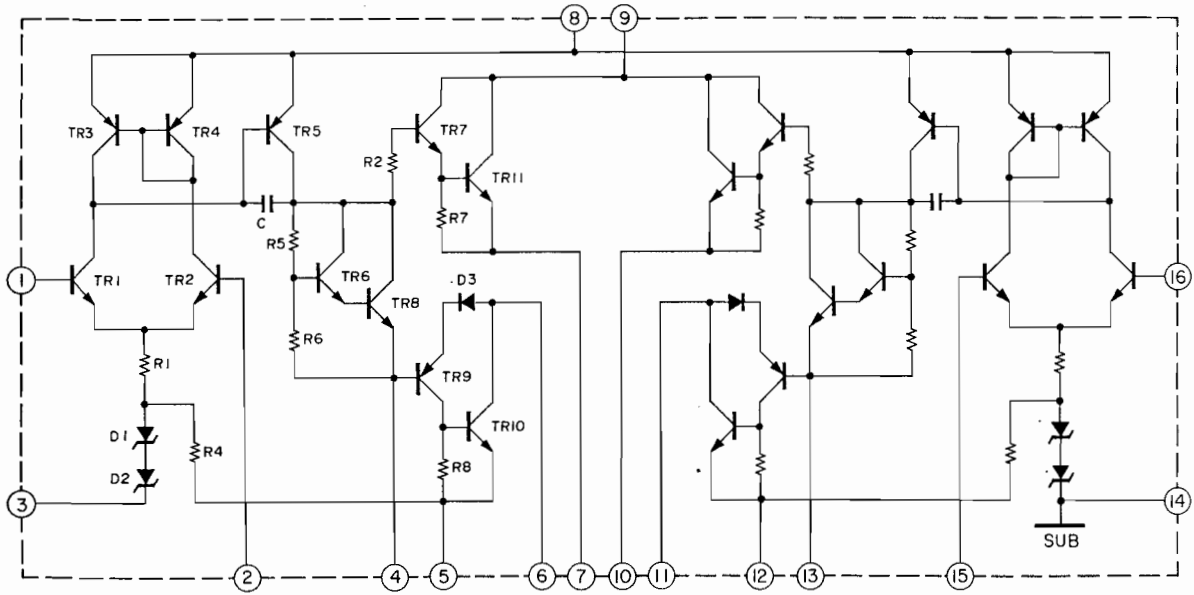

# STK-463SLY

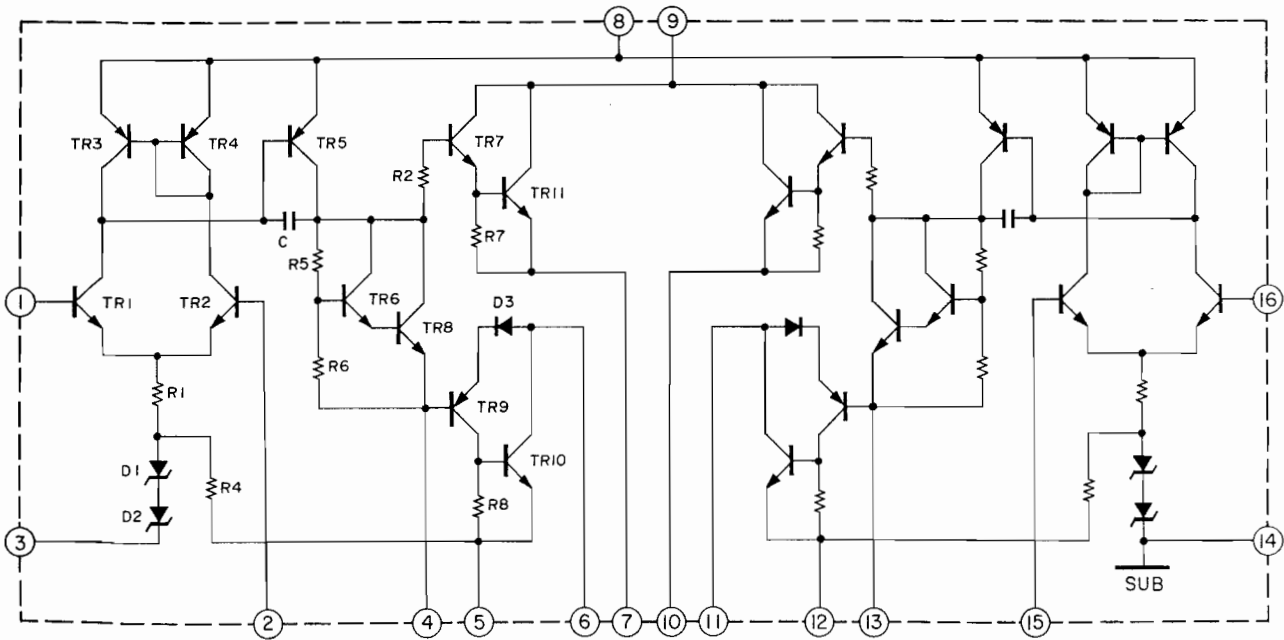

AT-K11

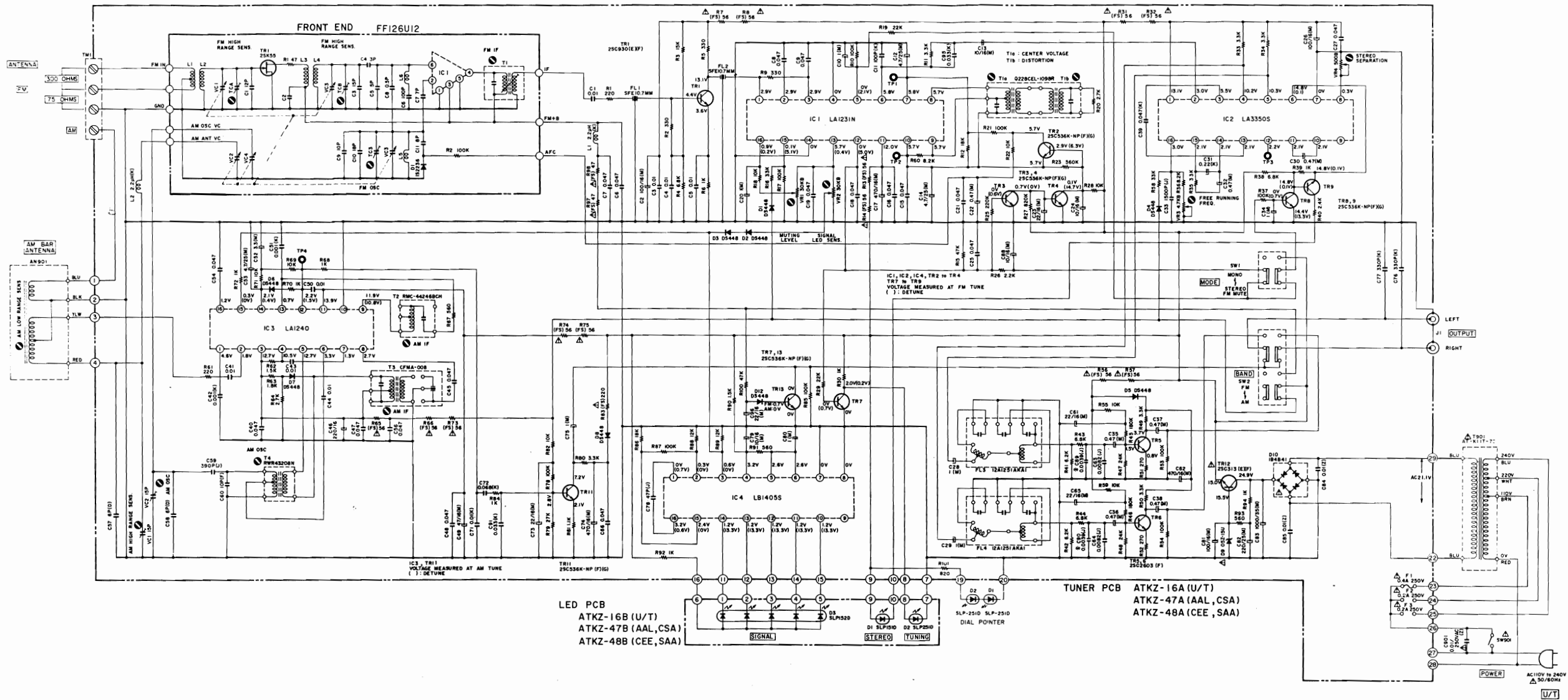

LED PCB  
 ATKZ-16B (U/T)  
 ATKZ-47B (AAL, CSA)  
 ATKZ-48B (CEE, SAA)

TUNER PCB ATKZ-16A (U/T)  
 ATKZ-47A (AAL, CSA)  
 ATKZ-48A (CEE, SAA)

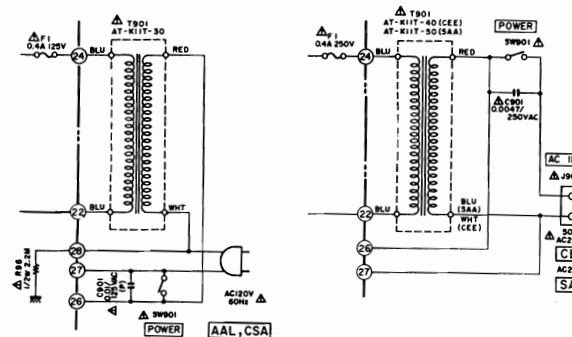

WARNING: INDICATES SAFETY CRITICAL COMPONENTS. FOR CONTINUED SAFETY, REPLACE SAFETY CRITICAL COMPONENTS ONLY WITH MANUFACTURER'S RECOMMENDED PARTS.  
 AVERTISSEMENT: IL INDIQUE LES COMPOSANTS CRITIQUES DE SÛRETÉ. POUR MAINTENIR LE DEGRÉ DE SÛRETÉ DE L'APPAREIL, NE REMPLACER LES COMPOSANTS SONT LE FONCTIONNEMENT EST CRITIQUE POUR LA SÛRETÉ QUE PAR DES PIÈCES RECOMMANDÉES PAR LE FABRICANT.

NOTE  
 UNLESS OTHERWISE SPECIFIED  
 ALL RESISTORS IN OHMS (1/4W, 1/2W)  
 ALL CAPACITORS IN µF (50 WV (2)  
 (FS) = FAIL SAFE RESISTORS  
 POWER TRANSFORMER IS DIFFERENT  
 ACCORDING TO AREA

AT-K11  
 SCHEMATIC DIAGRAM  
 No. 162640A

# AT-K11L SCHEMATIC DIAGRAM NO. 162641A

NOTE:  
UNLESS OTHERWISE SPECIFIED  
ALL RESISTORS IN OHMS (R VALUE)  
ALL CAPACITORS IN MICRO FARADS (M VALUE)  
F51 - FAIL SAFE RESISTORS  
POWER TRANSFORMER IS DIFFERENT  
ACCORDING TO AREA

WARNING: ANALYZES SAFETY CRITICAL COMPONENTS FOR CONTINUED SAFETY.  
RECOMMENDED PARTS  
MAINTENANCE: IN ORDER LES COMPOSANTS DE SURETE POUR  
MANTENIR LE DEGRE DE SECURITE DE L'APPAREIL. NE PAS ACHETER  
COMPOSANTS SONT LE Fournisseur RECOMMANDÉ PAR LE FABRICANT.  
UNE PAS DES PIÈCES RECOMMANDÉES PAR LE FABRICANT.

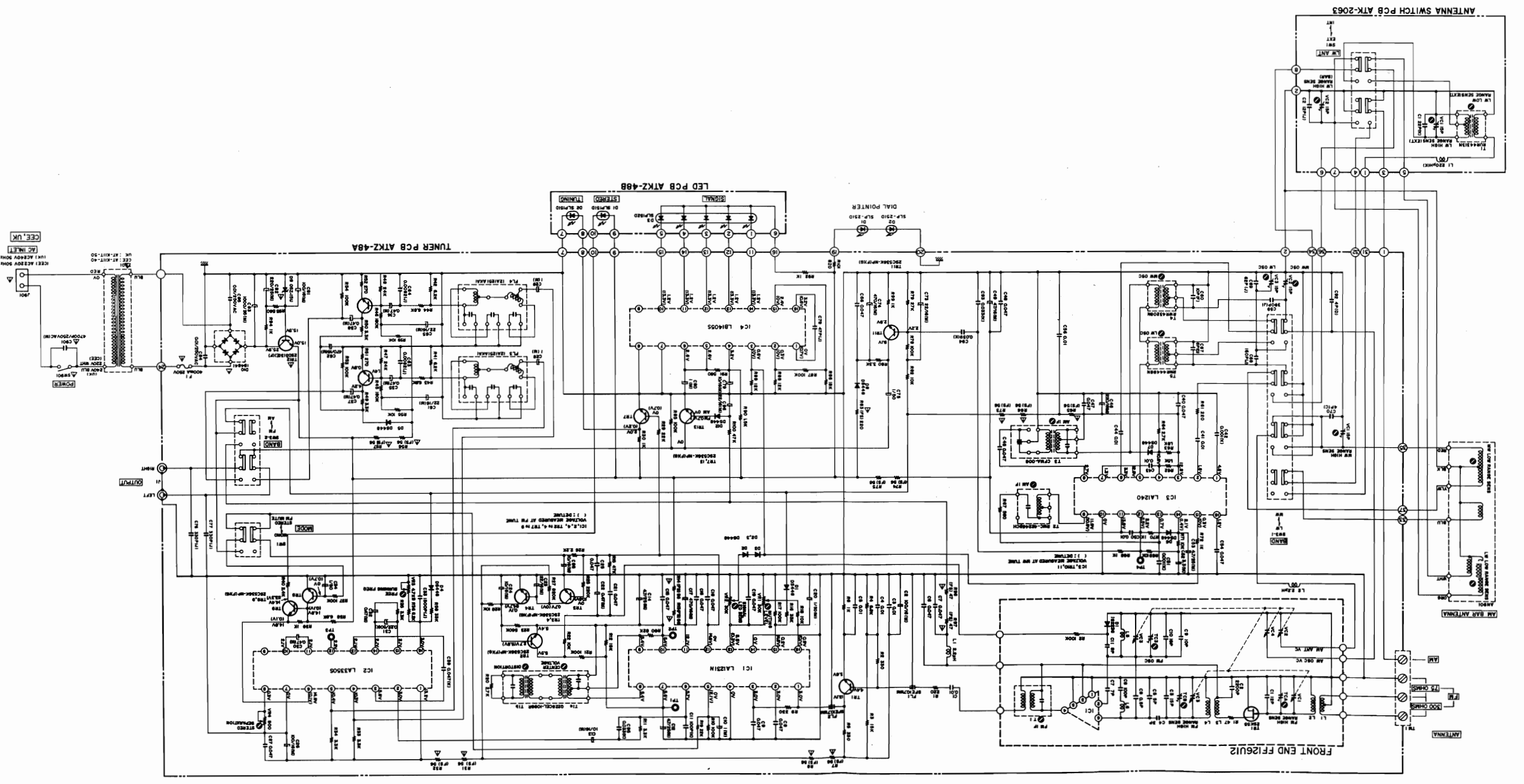

AT-K11L

CE-UM

CE-UM

CE-UM

CE-UM

CE-UM

CE-UM

CE-UM

CE-UM

CE-UM

CE-UM

CE-UM

CE-UM

CE-UM

CE-UM

CE-UM

CE-UM

CE-UM

CE-UM

CE-UM

CE-UM

CE-UM

CE-UM

CE-UM

CE-UM

CE-UM

CE-UM

CE-UM

CE-UM

CE-UM

CE-UM

CE-UM

CE-UM

CE-UM

CE-UM

CE-UM

CE-UM

CE-UM

CE-UM

CE-UM

CE-UM

CE-UM

CE-UM

CE-UM

CE-UM

CE-UM

CE-UM

CE-UM

CE-UM

CE-UM

CE-UM

CE-UM

CE-UM

CE-UM

CE-UM

CE-UM

CE-UM

CE-UM

CE-UM

CE-UM

CE-UM

CE-UM

CE-UM

CE-UM

CE-UM

CE-UM

CE-UM

CE-UM

CE-UM

CE-UM

CE-UM

CE-UM

CE-UM

CE-UM

CE-UM

CE-UM

CE-UM

CE-UM

CE-UM

CE-UM

CE-UM

CE-UM

CE-UM

CE-UM

CE-UM

CE-UM

CE-UM

CE-UM

CE-UM

CE-UM

CE-UM

CE-UM

CE-UM

CE-UM

CE-UM

CE-UM

CE-UM

CE-UM

CE-UM

CE-UM

CE-UM

CE-UM

CE-UM

CE-UM

CE-UM

CE-UM

CE-UM

CE-UM

CE-UM

CE-UM

CE-UM

CE-UM

CE-UM

CE-UM

CE-UM

CE-UM

CE-UM

CE-UM

CE-UM

CE-UM

CE-UM

CE-UM

CE-UM

CE-UM

CE-UM

CE-UM

CE-UM

CE-UM

CE-UM

CE-UM

CE-UM

CE-UM

CE-UM

CE-UM

CE-UM

CE-UM

CE-UM

CE-UM

CE-UM

CE-UM

CE-UM

CE-UM

CE-UM

CE-UM

CE-UM

CE-UM

CE-UM

CE-UM

CE-UM

CE-UM

CE-UM

CE-UM

CE-UM

CE-UM

CE-UM

CE-UM

CE-UM

CE-UM

CE-UM

CE-UM

CE-UM

CE-UM

CE-UM

CE-UM

CE-UM

CE-UM

CE-UM

CE-UM

CE-UM

CE-UM

CE-UM

CE-UM

CE-UM

CE-UM

CE-UM

CE-UM

CE-UM

CE-UM

CE-UM

CE-UM

CE-UM

CE-UM

CE-UM

CE-UM

CE-UM

CE-UM

CE-UM

CE-UM

CE-UM

CE-UM

CE-UM

CE-UM

CE-UM

CE-UM

CE-UM

CE-UM

CE-UM

CE-UM

CE-UM

CE-UM

CE-UM

CE-UM

CE-UM

CE-UM

CE-UM

CE-UM

CE-UM

CE-UM

CE-UM

CE-UM

CE-UM

CE-UM

CE-UM

CE-UM

CE-UM

CE-UM

CE-UM

CE-UM

CE-UM

CE-UM

CE-UM

CE-UM

CE-UM

CE-UM

CE-UM

CE-UM

CE-UM

CE-UM

CE-UM

CE-UM

CE-UM

CE-UM

CE-UM

CE-UM

CE-UM

CE-UM

CE-UM

CE-UM

CE-UM

CE-UM

CE-UM

CE-UM

CE-UM

CE-UM

CE-UM

CE-UM

CE-UM

CE-UM

CE-UM

CE-UM

CE-UM

CE-UM

CE-UM

CE-UM

CE-UM

CE-UM

CE-UM

CE-UM

CE-UM

CE-UM

CE-UM

CE-UM

CE-UM

CE-UM

CE-UM

CE-UM

CE-UM

CE-UM

CE-UM

CE-UM

CE-UM

CE-UM

CE-UM

CE-UM

CE-UM

CE-UM

CE-UM

CE-UM

CE-UM

CE-UM

CE-UM

CE-UM

CE-UM

CE-UM

CE-UM

CE-UM

CE-UM

CE-UM

CE-UM

CE-UM

CE-UM

CE-UM

CE-UM

CE-UM

CE-UM

CE-UM

CE-UM

CE-UM

CE-UM

CE-UM

CE-UM

CE-UM

CE-UM

CE-UM

CE-UM

CE-UM

AT-K22

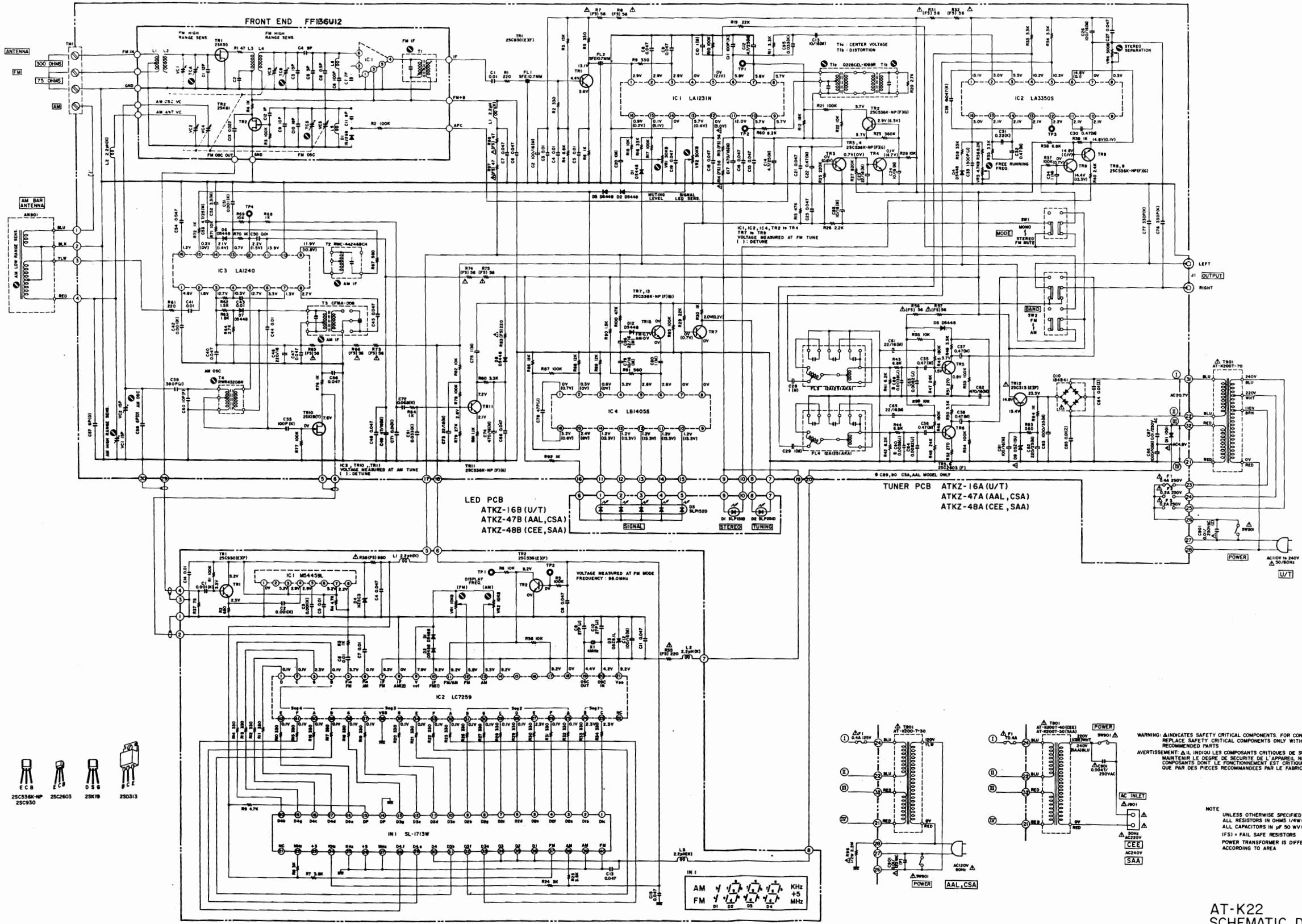

WARNING: INDICATES SAFETY CRITICAL COMPONENTS. FOR CONTINUED SAFETY, REPLACE SAFETY CRITICAL COMPONENTS ONLY WITH MANUFACTURER'S RECOMMENDED PARTS.  
 AVERTISSEMENT: IL INDIQUE LES COMPOSANTS CRITIQUES DE SURETE. POUR MAINTENIR LE DEGRE DE SECURITE DE L'APPAREIL, NE REMPLACEZ LES COMPOSANTS DONT LE FONCTIONNEMENT EST CRITIQUE POUR LA SECURITE QUE PAR DES PIECES RECOMMANDEES PAR LE FABRICANT.

NOTE  
 UNLESS OTHERWISE SPECIFIED  
 ALL RESISTORS IN OHMS (1/4W/1%)  
 ALL CAPACITORS IN µF (50 WV/12)  
 (F5) = FAIL SAFE RESISTORS  
 POWER TRANSFORMER IS DIFFERENT  
 ACCORDING TO AREA

AT-K22  
 SCHEMATIC DIAGRAM  
 No. 162642A

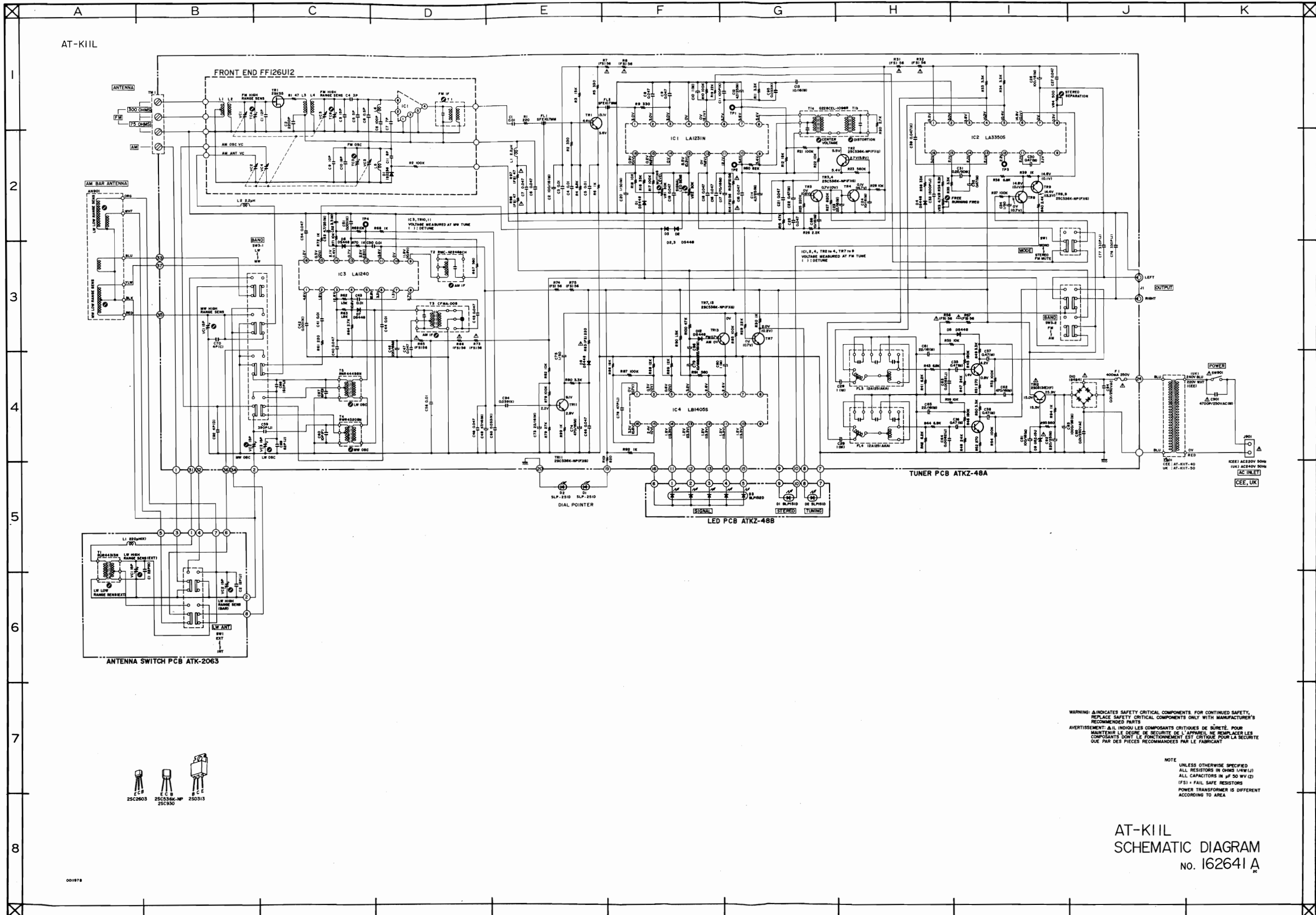

WARNING: Δ INDICATES SAFETY CRITICAL COMPONENTS. FOR CONTINUED SAFETY, REPLACE SAFETY CRITICAL COMPONENTS ONLY WITH MANUFACTURER'S RECOMMENDED PARTS.  
 AVERTISSEMENT: Δ IL INDIQUE LES COMPOSANTS CRITIQUES DE SÛRETÉ. POUR MAINTENIR LE DEGRÉ DE SÛRETÉ DE L'APPAREIL, NE REMPLACEZ LES COMPOSANTS DONT LE FONCTIONNEMENT EST CRITIQUE POUR LA SÛRETÉ QUE PAR DES PIÈCES RECOMMANDÉES PAR LE FABRICANT.

NOTE: UNLESS OTHERWISE SPECIFIED, ALL RESISTORS IN OHMS (1/W/L), ALL CAPACITORS IN μF 50 WV (2). (F3) = FAIL SAFE RESISTORS. POWER TRANSFORMER IS DIFFERENT ACCORDING TO AREA.

AT-KIIL  
 SCHEMATIC DIAGRAM  
 NO. 162641 A

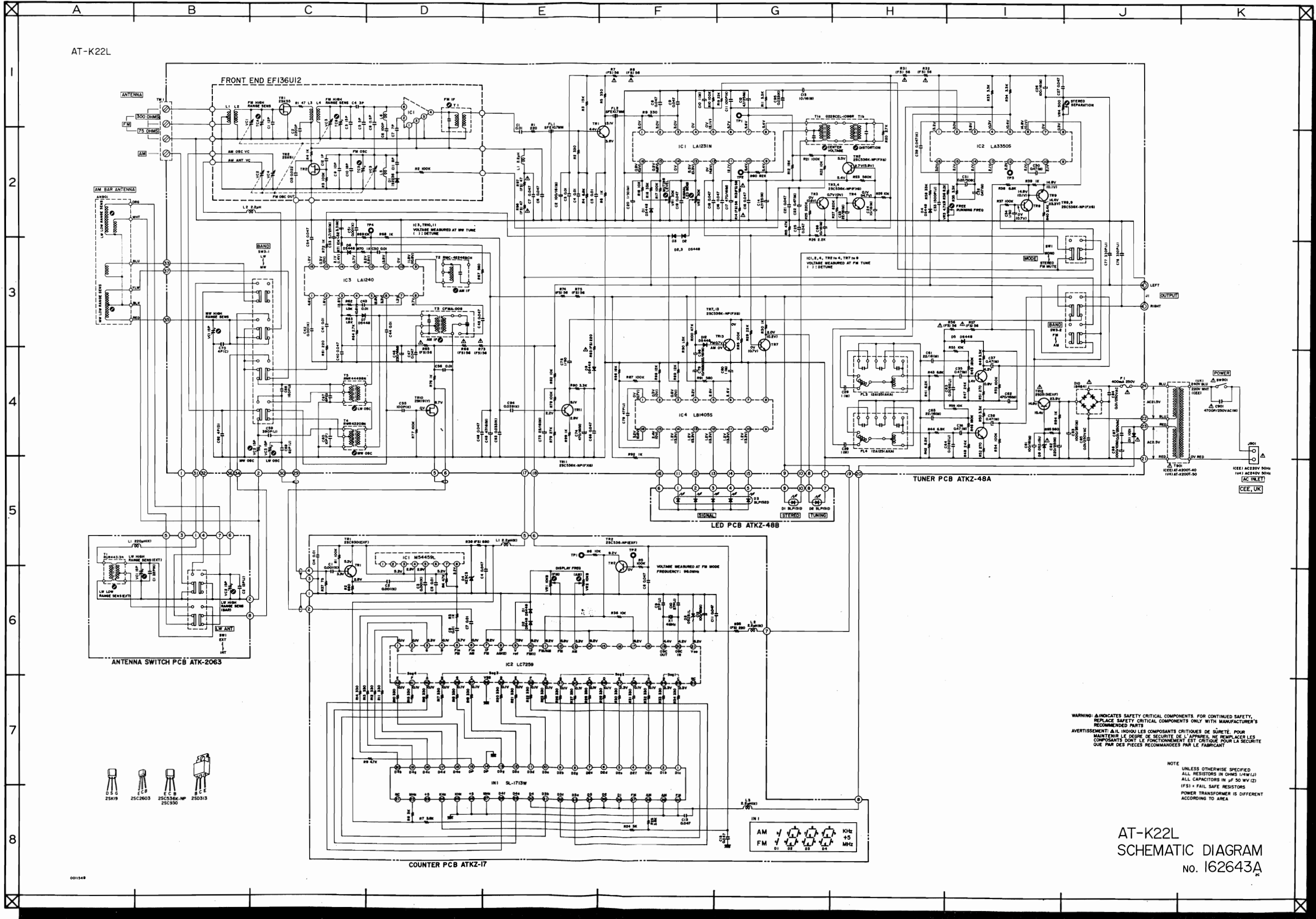

AT-K22L

ANTENNA SWITCH PCB ATK-2063

FRONT END EF136UI2

TUNER PCB ATKZ-48A

LED PCB ATKZ-48B

COUNTER PCB ATKZ-17

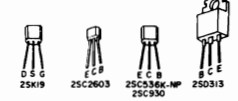

WARNING: INDICATES SAFETY CRITICAL COMPONENTS FOR CONTINUED SAFETY. REPLACE SAFETY CRITICAL COMPONENTS ONLY WITH MANUFACTURER'S RECOMMENDED PARTS.  
 AVERTISSEMENT: IL INDIQUE LES COMPOSANTS CRITIQUES DE SÛRETÉ. POUR MAINTENIR LE DEGRÉ DE SÛRETÉ DE L'APPAREIL, NE REMPLACEZ LES COMPOSANTS DONT LE FONCTIONNEMENT EST CRITIQUE POUR LA SÛRETÉ QUE PAR DES PIÈCES RECOMMANDÉES PAR LE FABRICANT.

NOTE  
 UNLESS OTHERWISE SPECIFIED  
 ALL RESISTORS IN OHMS 1/4W(1)  
 ALL CAPACITORS IN pF 50 WV(2)  
 (F51) = FAIL SAFE RESISTORS  
 POWER TRANSFORMER IS DIFFERENT  
 ACCORDING TO AREA

AT-K22L  
 SCHEMATIC DIAGRAM  
 No. 162643A

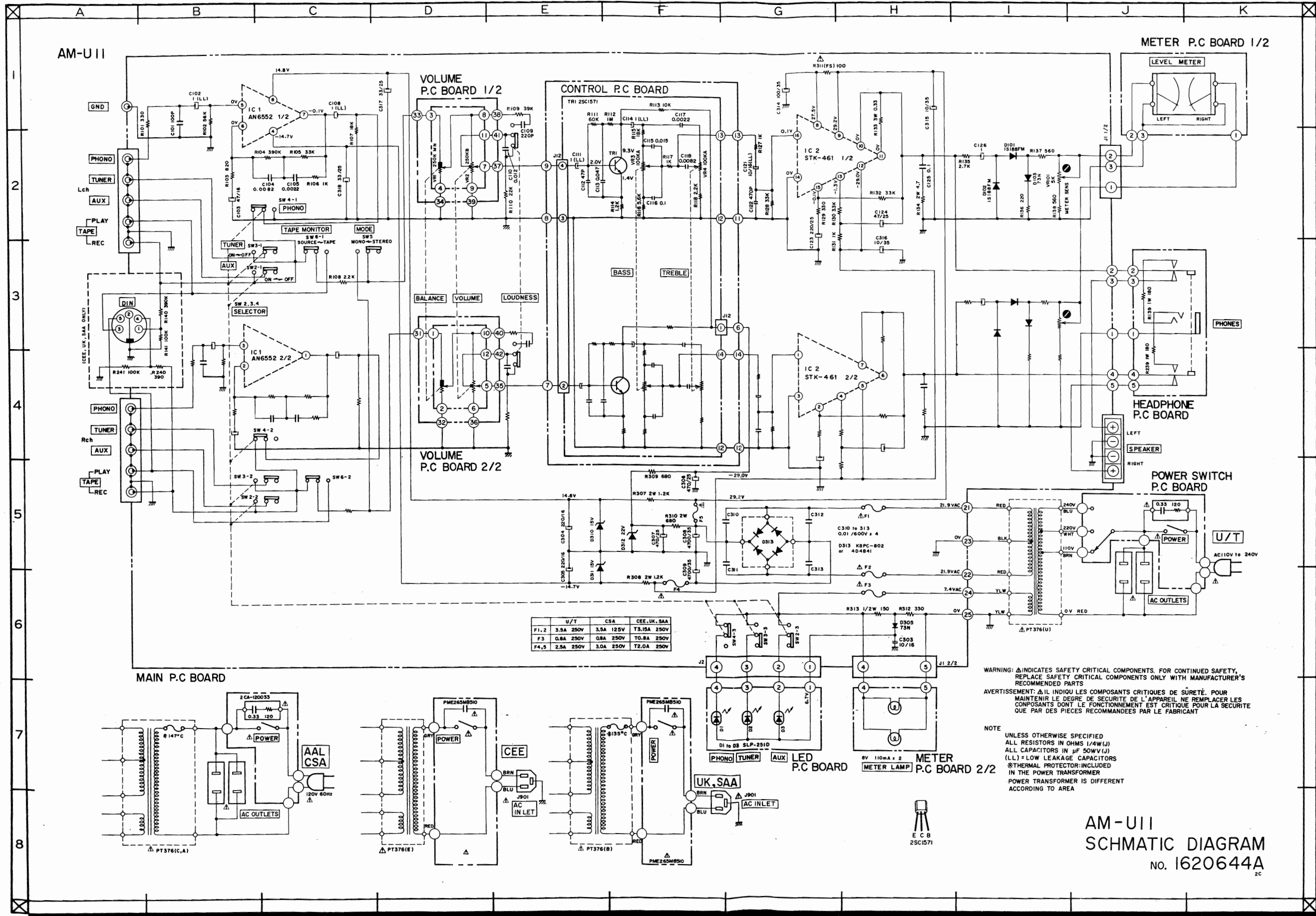

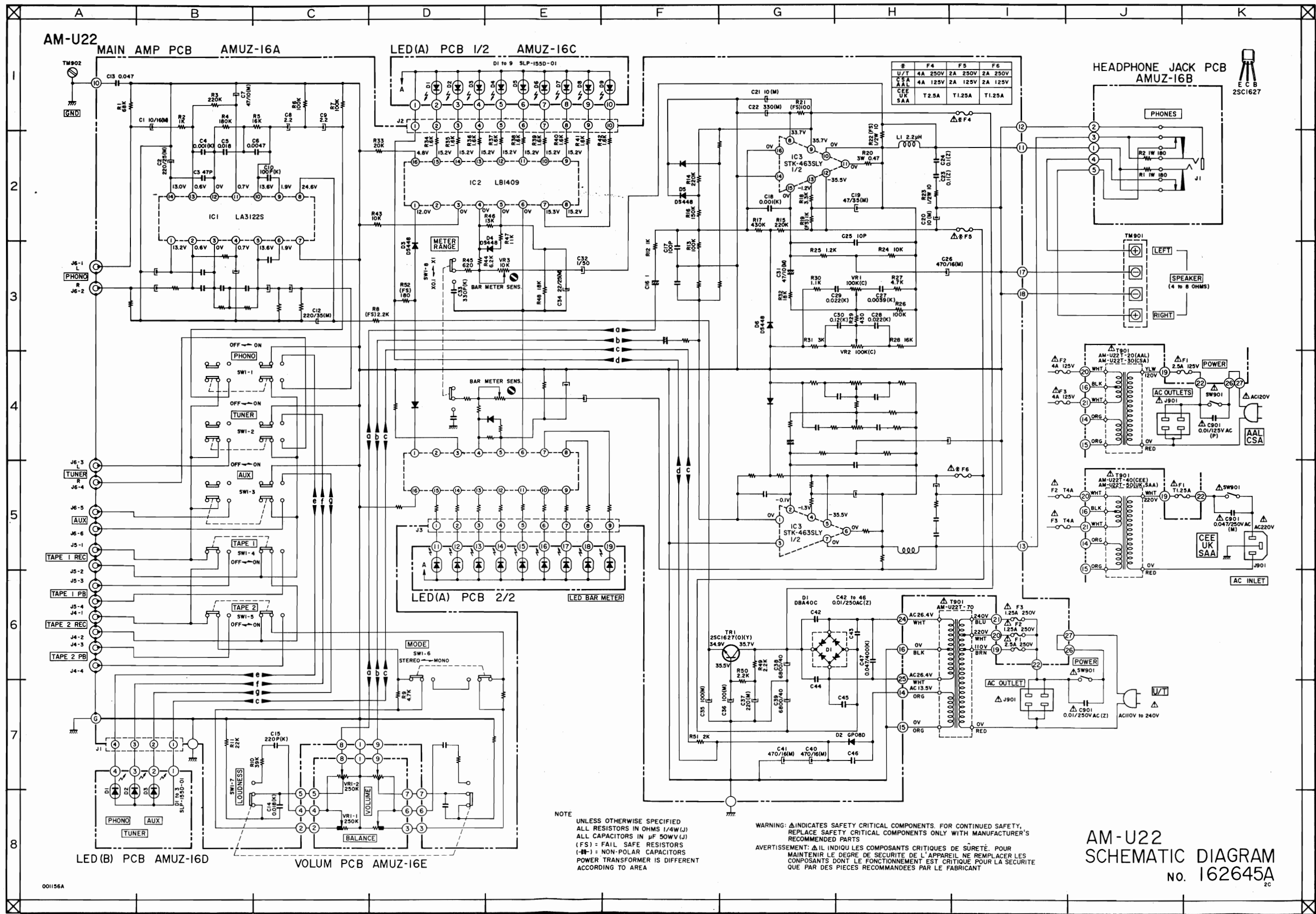

001156A

AM-U22  
 SCHEMATIC DIAGRAM  
 No. 162645A